

BERNINA®



BERNINA® 1630

Inspiration plus

Instruction Manual



IMPORTANT SAFETY INSTRUCTIONS

When using an electrical appliance, basic safety precautions should always be followed, including the following. Read all instructions before using this sewing machine.

Danger



To reduce the risk of electric shock:

1. An appliance should never be left unattended when plugged in.
2. Always unplug this appliance from the electric outlet immediately after using and before cleaning.
3. Always unplug before relamping. Replace the bulb with the same type rated 6 volts/4 watts.

Warning

To reduce the risk of burns, fire, electric shock or injury to persons:

1. Do not allow to be used as a toy. Close attention is necessary when this appliance is used by or near children.
2. Use appliance only for its intended use as described in this manual. Use only attachments recommended by the manufacturer as contained in this manual.
3. Never operate this appliance if it has a damaged cord or plug, if it is not working properly, if it has been dropped or damaged or dropped into water. Return the appliance to the nearest authorized dealer or service center for examination, repair, electrical or mechanical adjustment.

4. Never operate the appliance with any air openings blocked. Keep ventilation openings of the sewing machine and foot controller free from accumulation of lint, dust and loose cloth.
5. Keep fingers away from all moving parts. Special care is required around the sewing needle.
6. Always use the proper needle plate. The wrong plate can cause the needle to break.
7. Do not use bent needles.
8. Do not pull or push fabric while stitching. It may deflect the needle causing it to break.
9. Switch the sewing machine off  when making any adjustments in the needle area, such as threading or changing the needle, threading the bobbin or changing the presser foot and the like.
10. Always unplug the sewing machine from the electrical outlet when removing covers, lubricating or when making any other user servicing adjustments mentioned in this instruction manual.
11. Never drop or insert any object into any opening.
12. Do not use outdoors.
13. Do not operate where aerosol (spray) products are being used or where oxygen is being administered.
14. To disconnect, turn all controls to the off  position then remove the plug from the outlet.
15. Do not unplug by pulling on the cord but grasp the plug.
16. Appliances provided with a cord reel: Hold plug when rewinding into cord reel. Do not allow the plug to whip when rewinding.
17. This appliance is provided with double insulation. Use only identical replacement parts. See instructions for Servicing Double Insulated appliances.

Servicing double-insulated products

In a double-insulated product, two systems of insulation are provided instead of grounding. No grounding means is provided on a double-insulated product nor should a means for grounding be added to the product. Servicing a double-insulated product requires extreme care and knowledge of the system and should only be done by qualified service personnel. Replacement parts for a double-insulated product must be identical to those parts in the product. A double-insulated product is marked with the words «DOUBLE INSULATION» or «DOUBLE INSULATED».

The symbol  may also be marked on the product

SAVE THESE INSTRUCTIONS!

This sewing machine is intended for household use only.

| | |
|------------------------|----|
| Setting up the machine | 1 |
| <hr/> | |
| Menus | 11 |
| Presser feet | |
| Practical stitches | |
| Buttonholes | |
| <hr/> | |
| General Instructions | 21 |
| Functions | |
| <hr/> | |
| Practical sewing | 27 |
| <hr/> | |
| Decorative sewing | 53 |
| <hr/> | |
| Needles | 71 |
| Threads | |
| <hr/> | |
| Troubleshooting | 75 |
| Maintenance | |
| <hr/> | |
| Bernina Publications | 81 |
| <hr/> | |
| Index | 83 |



Dear Bernina Customer

Congratulations on your choice of a Bernina 1630 Inspiration plus. You are now the proud owner of a sewing machine which fulfils every expectation in terms of use and quality. You own an excellent product which will give you sewing pleasure for many years to come.

In 1893, my great grandfather invented the world's first hemstitch machine. This was the beginning of the Bernina family company of which I am proud to be the fourth generation president. I am delighted to welcome you to the millions of satisfied Bernina owners around the world.

If you require any further information about your sewing machine or sewing in general, please do not hesitate to contact your Bernina dealer who will be delighted to help and advise you.

I wish you very happy and successful sewing.

Yours truly

Hanspeter Ueltschi
President

BERNINA®

Controls Functions

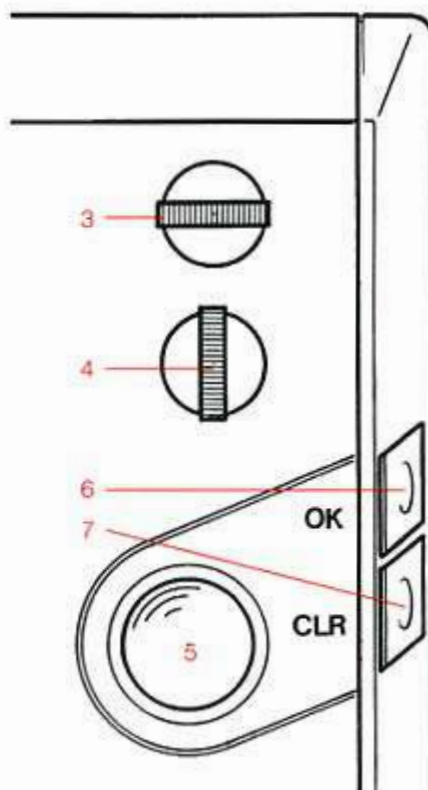
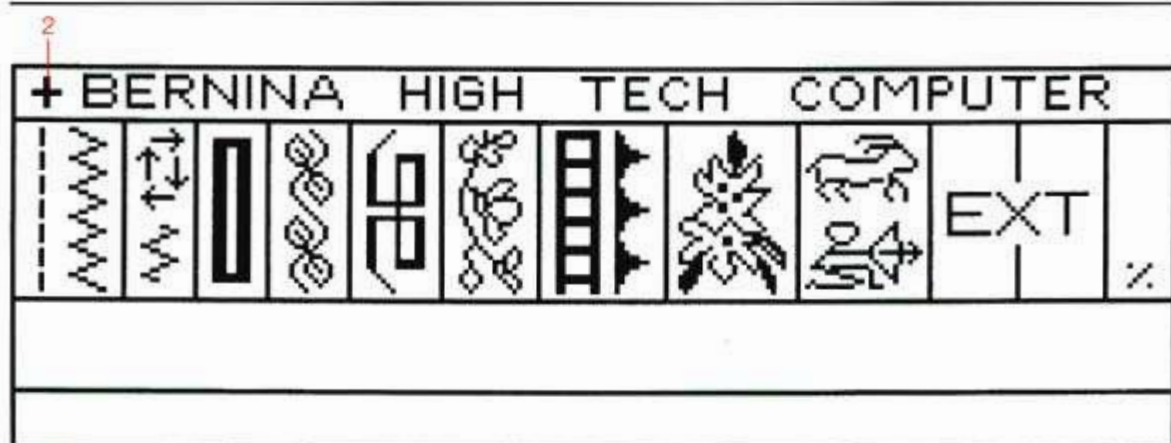

- 1 Main Menu
- 2 Cursor
- 3 Stitch width dial
- 4 Stitch length dial
- 5 Command ball
- 6 OK button
- 7 CLR (clear) button
- 8 Letter coded menu
- 9 Back to menu
- 10 Sewing speed
- 11 Needle stop up/down
- 12 Reverse sewing
- 13 Long stitch
- 14 Basting stitch
- 15 Pattern begin
- 16 1/2 pattern
- 17 Pattern end
- 18 Securing function
- 19 Presser foot indicator
- 20 Bobbin thread control
- 21 Memory
- 22 Save/leave memory
- 23 Memory subdivision
- 24 Mirror image right-left
- 25 Mirror image vertical
- 26 Pattern extension
- 27 Double needle limitation
- 28 Vertical balance
- 29 Horizontal balance
- 30 Stitch width indication
- 31 Stitch length indication
- 32 Needle positions
- 33 Next screen
- 34 Previous screen
- 35 Programming screen

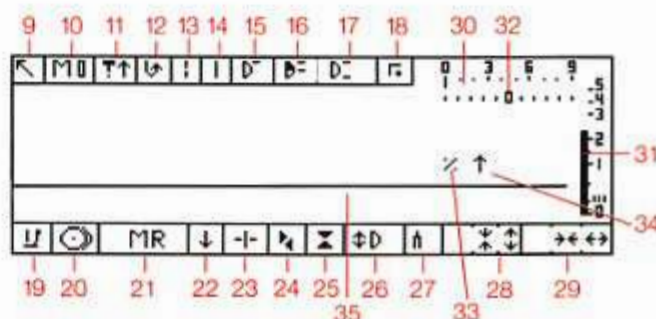
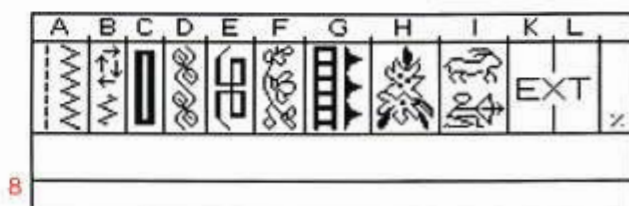

Setting up the machine

Carrying case



Carrying case/ accessories

The carrying case protects the machine from dust and dirt.

Always carry the machine by its handle.



Grasp both sides of the carrying case and lift it off the machine.



The case has a built-in accessory compartment. Press the regulating bar «T» to swing out the compartment which provides storage space for the foot controller, presser foot lifter, sewing table and instruction book.

Important! (USA/Canada only)

This sewing machine has a polarized plug (one blade wider than the other). To reduce the risk of electric shock, this plug is intended to fit in a polarized outlet only one way. If the plug does not fit fully in the outlet, reverse the plug. If it still does not fit, contact a qualified electrician to install the proper outlet. Do not modify the plug in any way.

Use only the following foot controllers:

Type 290 with model(s) 1000, 1001, 1006, 1011
Type 11 with model(s) 1031
Type 11/366 with model(s) 1080, 1090, 1260
Type 01 with model(s) 1530, 1630

Accessory box

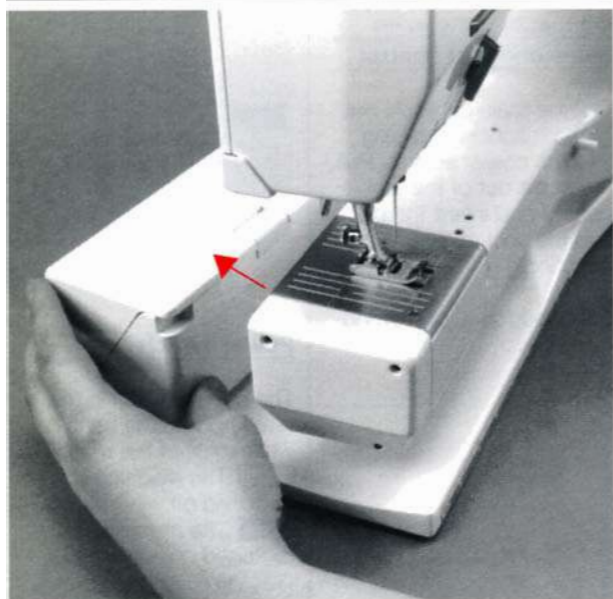

Removing the accessory box

Simply push the box backwards.

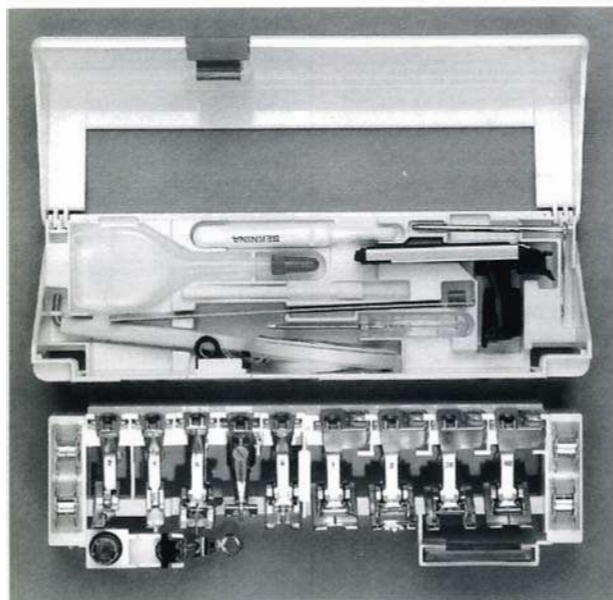

Accessory box

Accessories are neatly arranged and easy to remove.

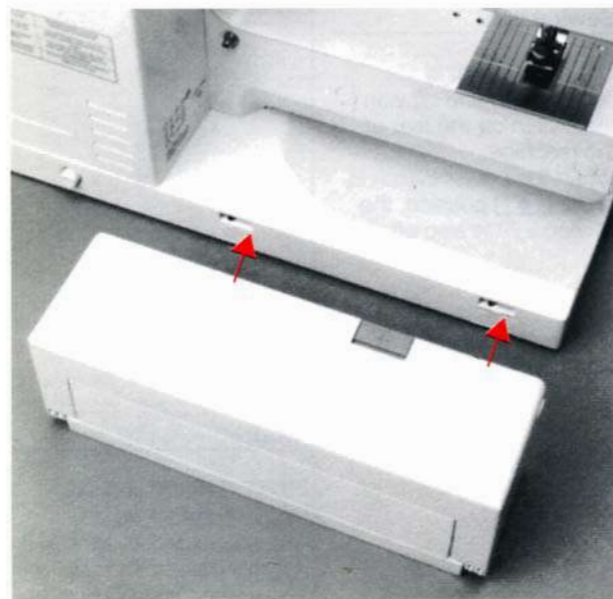

Replacing the accessory box

The box has two fixing lugs which fit into the baseplate of the machine.

Lay the box onto the baseplate from the back and press against the free arm until the fixing lugs engage.

Bernina 1630

Standard accessories

5 bobbins
130/705H needles
Ruler/template
Seam ripper
Darning ring with arm
Needle threader
Small screwdriver
Special screwdriver
Cleaning brush
Oiler
Seam/quilting guide
Coded reverse pattern foot
Overlock foot
Coded buttonhole foot
Automatic buttonhole foot
Zip foot
Blind stitch foot
Coded open embroidery foot
Jeans foot
Darning foot
Button sewing-on foot
Coded sideways motion foot

Mains cable, foot control, sewing light, power switch, needle stop

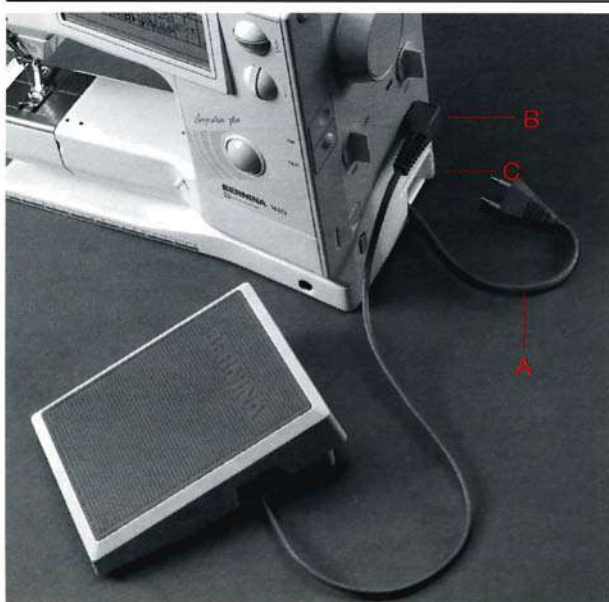

Connecting the main cable and foot control

Pull the main cable (A) out of the machine and plug into the power socket. Pull the cable out of the foot control and insert the plug into the socket (B) in either direction.

Press button (C) to rewind the cable.

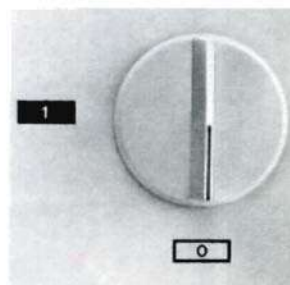

Power switch

The power switch is the rear knob on the hand-wheel side of the machine.

0 The machine is switched off.

1 The machine is switched on.

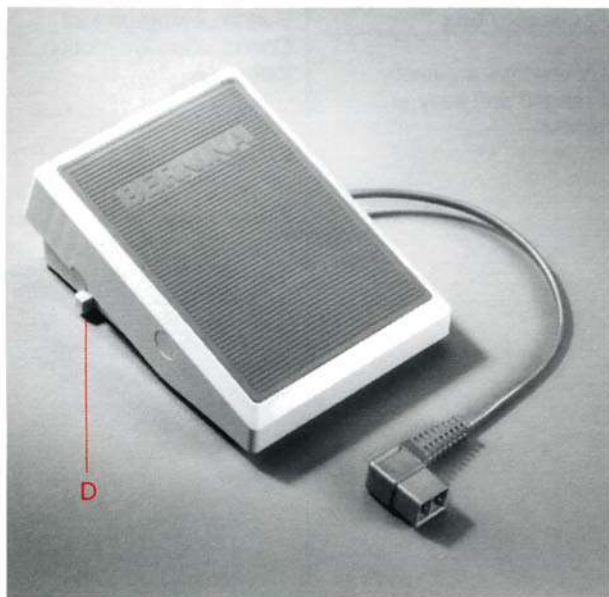

Foot control

The foot control is used to regulate the sewing speed. It is fitted with a retractable cable. Press knob (D) to rewind the cable.

The sewing speed can be controlled from absolute minimum to maximum speed by varying the pressure on the plate of the control.

Electronic needle stop and foot control

When you stop sewing the electronic system returns the needle to its highest or lowest position. By gently tapping the back of the foot control with your heel, the needle can be moved up or down.

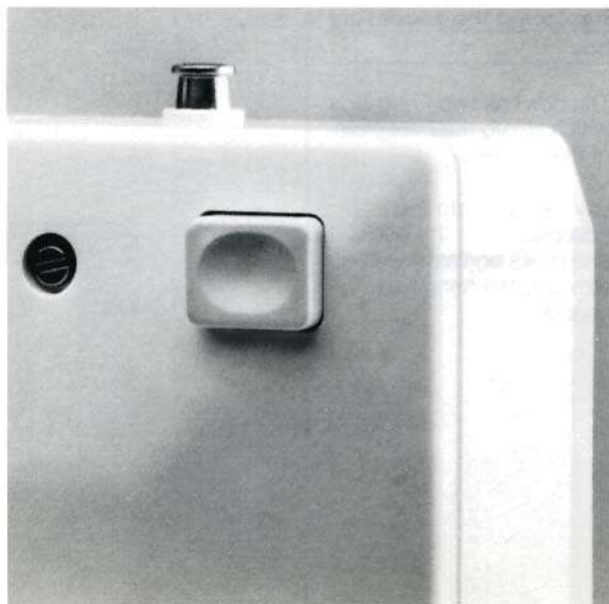

Sewing light

The sewing light is switched on and off with the switch on the rear of the machine.

When the power switch is in the **0** position, the sewing light is also off.

Motor

The DC motor and electronic speed control provide exceptionally good needle penetration power even when sewing slowly.

Sewing table with seam guide and measurement scale

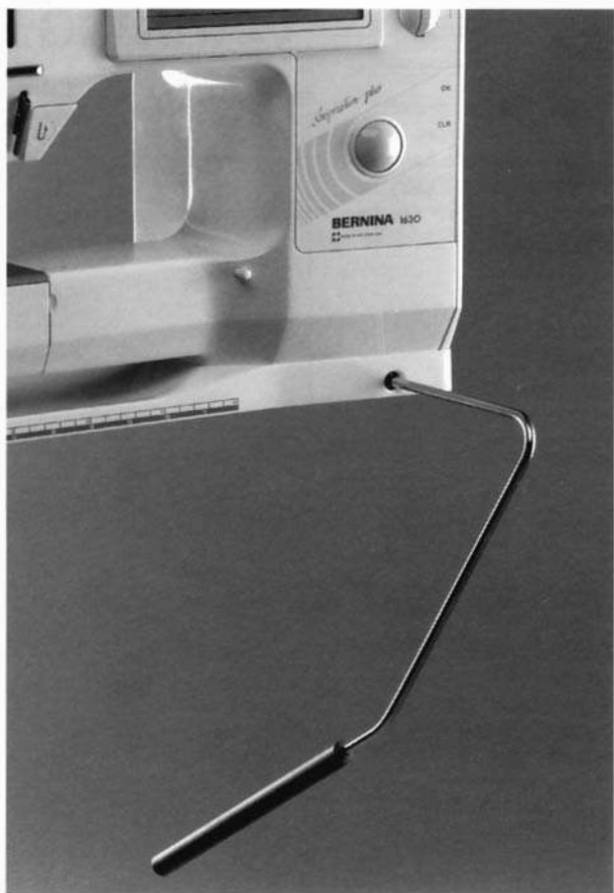

Raise the presser foot Lower the feed-dog

Many sewing operations are much simpler if both hands are free to guide the work.

The presser foot lifter is operated by the right knee and is used to raise and lower the presser foot, leaving both hands free.

When the presser foot lifter is moved to the right, the presser foot is raised and at the same time the feed-dog is lowered.

The next stitch returns the feed-dog to sewing position.

Attaching the presser foot lifter

The presser foot lifter is stored in the carrying case (see picture on page 8). The presser foot lifter socket is located on the front right hand side of the base plate. Insert the presser foot lifter so that it hangs to the left.

It should be possible to operate the presser foot lifter comfortably with the right knee, without need to alter the customary sitting position. If the angle of the presser foot lifter is uncomfortable, it can be adjusted.

Your BERNINA dealer will be pleased to make this adjustment for you.



Fitting the sewing table

Slide the table along the free arm until the centering pins engage in the holes provided. Press firmly from the left to lock the sewing table in position on the machine.

Sewing table with seam guide and measurement scale

The sewing table enlarges the working surface and simplifies all sewing work where the free-arm is not required.

The seam guide is pushed from the left into the groove on the underside of the table and can be adjusted over the whole width of the sewing table.

Removing the sewing table

Push firmly to the left (away from the machine) to release the sewing table.

The seam guide is in addition to the small ruler provided in the accessory box and allows you to sew and guide any seam width up to 15 cm (6").

The «0» on the measurement scale represents the centre needle position.

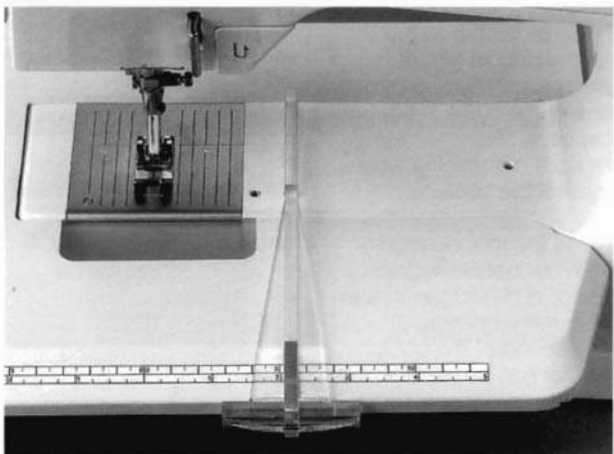

Bobbin case and bobbin, winding the lower thread

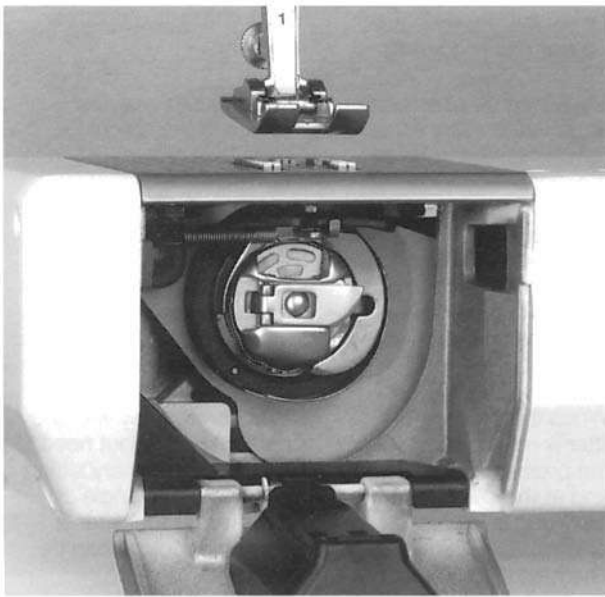

▲1

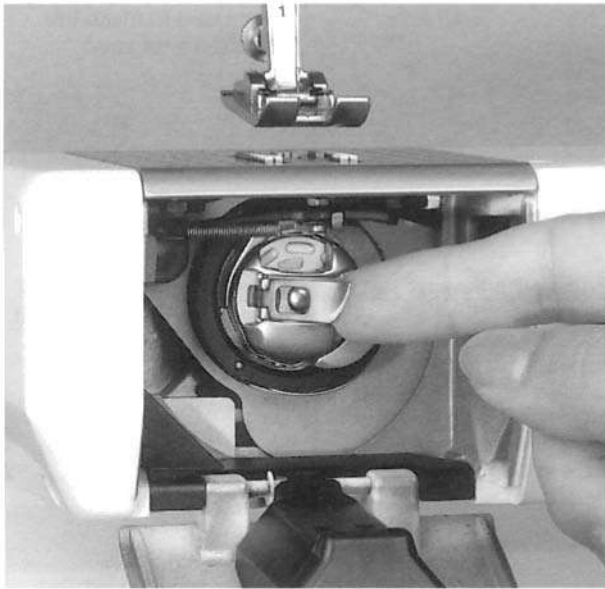

▲2

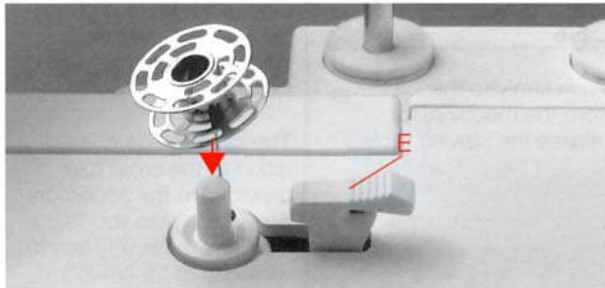

▲3

▼4

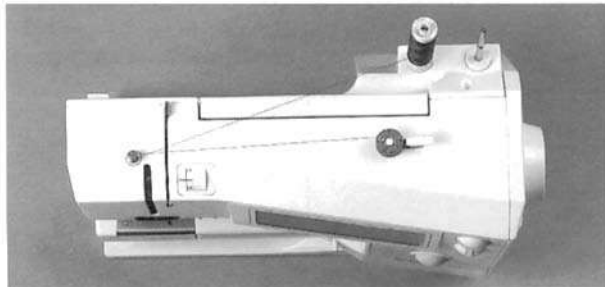

Removing the bobbin case

Turn the power switch to the **0** position. Raise the needle fully with the handwheel. Open the hinged front cover on the free arm (fig. 1).

Pull the bobbin case latch forward with the index finger of the right hand (fig. 2) and remove the bobbin case.

Winding the lower thread

Turn power switch to position **1**. Place empty bobbin on spindle (fig. 3). Take thread from the reel on the spool holder pin clockwise around the pretension stud to the empty bobbin (fig. 4). Bring the thread up through one of the holes in the bobbin case. Press the engaging lever E against the bobbin.

Press the foot control to start the bobbin winder motor and hold the thread end until it breaks. The speed of the bobbin winder can be regulated by increasing or decreasing the pressure on the foot control.

WARNING:

Please refer to the safety instructions.



▲5

When removing the bobbin, take the thread over the small knife (fig. 5) to cut it.

Inserting the bobbin

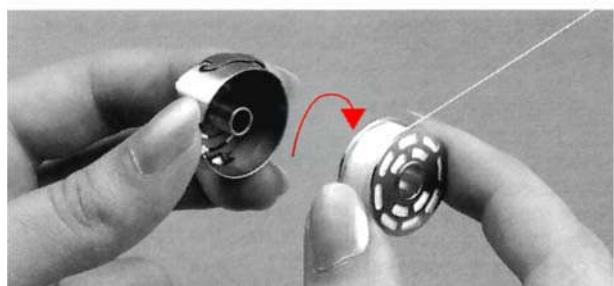

Inserting the bobbin

Hold the bobbin case in the left hand.

Insert the bobbin with the thread running in a clockwise direction (see arrow).

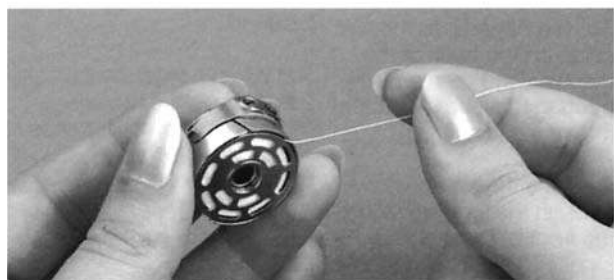

Bring thread anticlockwise into the slot.



Pull the thread into the slot and

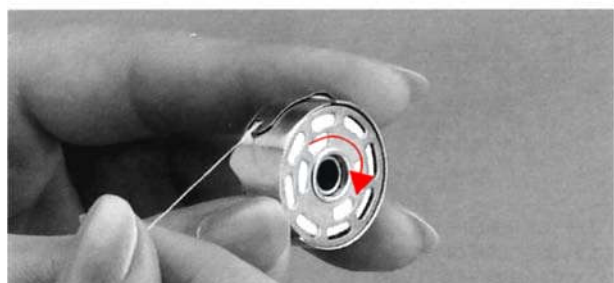

under the spring until it lies in the T-shaped slot at the end of the spring. When the thread is pulled, the bobbin should turn clockwise in the direction of the arrow.

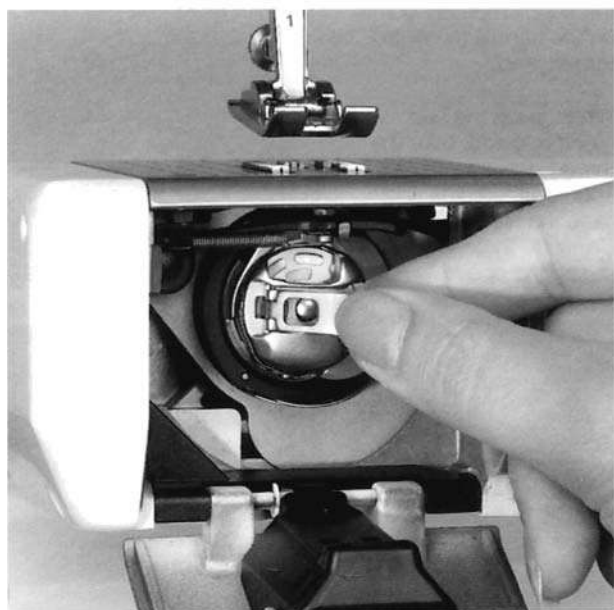

Inserting the bobbin case into the hook

Hold the bobbin case by the latch with the index finger and thumb of the right hand and insert with the cut-out on the bobbin case pointing upwards. Check: Pull the thread end. Close the hinged front cover.

Bobbin thread control

The bobbin thread control monitors the amount of thread left on the bobbin. When approx. 2-5 m/yds of thread remain (depending on the thickness), the symbol on the screen will invert and start to blink = rewind the lower thread. After rewinding, move the cursor to the blinking symbol and press the OK button. The symbol will stop blinking and return to its original form.

The bobbin thread control only works when the hinged cover is closed!

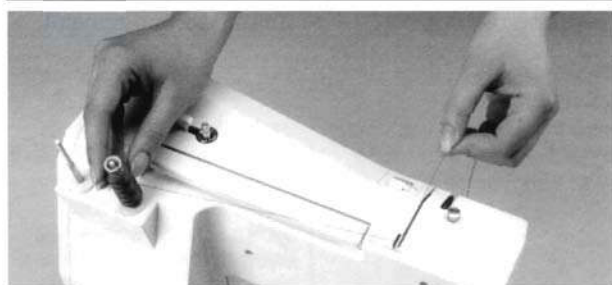

▲1

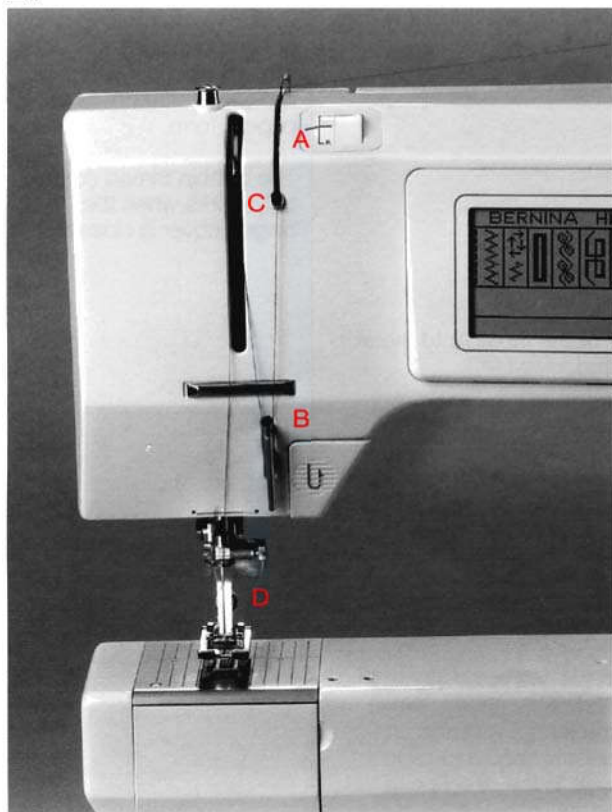

▲2

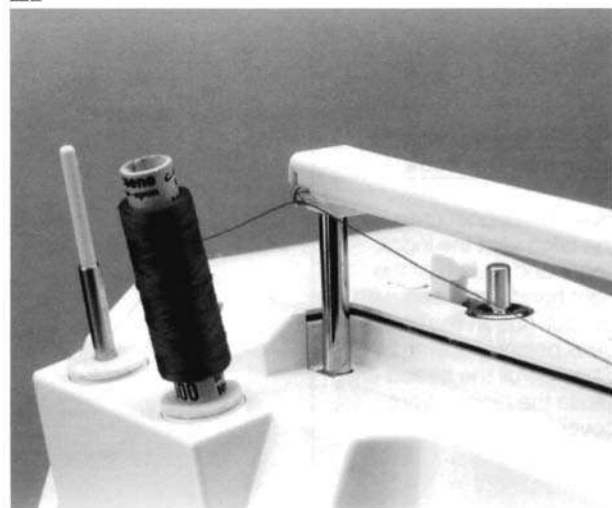

▲3

Threading the upper thread

Turn the power switch to

0

Check that the needle is fully raised. Raise the presser foot. Place thread spool on one of the spool holders and hold while threading.

Slip the thread into the first guide on the back of the machine and then take it through the long slit on the thread tension (fig. 1).

Take the thread down through the long slot A on the front of the machine, slip it into the thread regulator B, up into the slit of the thread take-up C and down again to the thread guide D on the needle clamp (fig. 2).

Thread the needle from front to back.

The eye of the needle is easy to see against the white plate on the presser foot shaft. Pull the thread approx. 10 cm (4") through the needle.

When using special threads such as metal or embroidery threads which wind quickly off the spool, thread the supplementary guide on the handle to control the thread feed.

When using the supplementary guide, take the thread directly from the spool to the guide and raise the handle (fig. 3). Continue threading as described above.

Quick needle threader

The needle threader is positioned on the right of the machine under the handwheel.

a) Lay the thread lightly across the threader.

b) Run the threader down the needle from top to bottom.

c) When it reaches the eye, press the threader gently and remove it once the thread is through the needle eye.

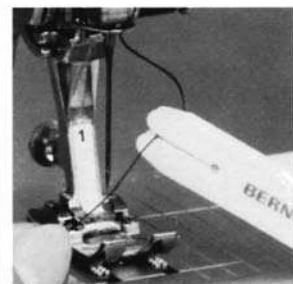

▲ a)

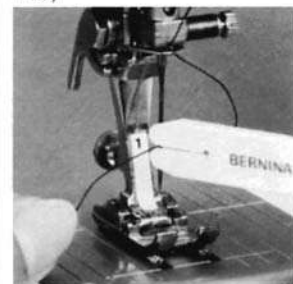

▲ b)

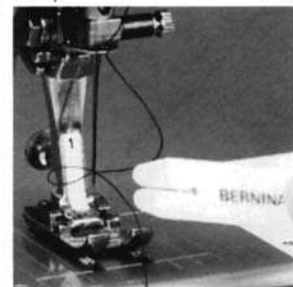

▼ c)

WARNING:

Please refer to the safety instructions.

Bringing up the lower thread, thread tension, feed-dog



▲1

Bringing up the lower thread

Turn the power switch to **1**. Hold the end of the upper thread and sew a stitch by tapping the foot control once. Pull the upper thread to bring the lower thread up through the stitch plate hole (fig. 1). Take both threads through the slot in the presser foot and to the side of the foot.

Instead of tapping the foot control, the lower thread can be brought up by turning the handwheel forwards until the needle is in its highest position.

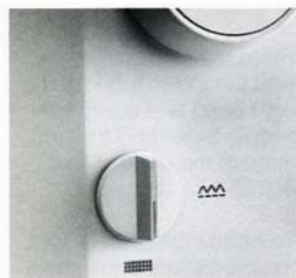

▲2

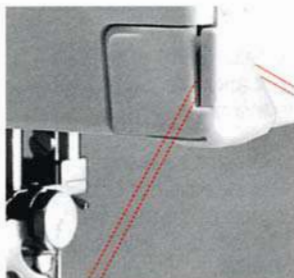

▲3

Lowering the feed-dog

For certain types of sewing, e.g. darning, the fabric must not be moved by the feed-dog.

To lower the feed-dog, turn the knob on the handwheel side of the machine to the right until it points to the symbol  (fig. 2).

For normal sewing, the knob should face the symbol .



▲4

Thread cutter

To remove your work, raise the presser foot, take the work out to the rear left and hook both threads into the cutter. The threads ends remain secure until sewing is continued (fig. 3).

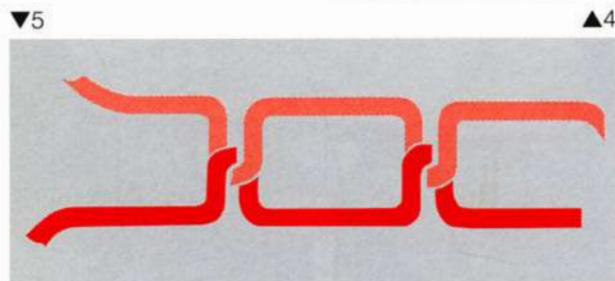

▼5

Thread tension

One of the main advantages of BERNINA machines is that there is very rarely any need to alter the thread tension for normal sewing. For the normal tension setting, the red mark on the tension regulating dial should match the adjacent mark on the machine (fig. 4). For special sewing, the thread tension can be adjusted with the aid of the regulating dial. Turning the tension regulating dial forwards, to number 4 or below, gives a looser upper thread tension. Turning the tension regulating dial backwards, to number 6 or above, gives a tighter upper thread tension. When the tension is **correctly** set, the upper and lower threads form loops between the two layers of fabric (fig. 5).

Incorrect upper thread tension will produce knots, loose loops or thread breakage. If tension is too loose knots will form on the underside (fig. 6). If tension is too tight knots will form on the upperside (fig. 7).

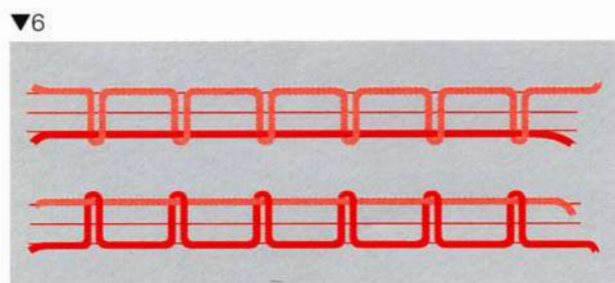

▼6

Important!

The thread tension should be reset to normal when the special sewing has been completed.

▲7

Inserting the needle, changing presser feet

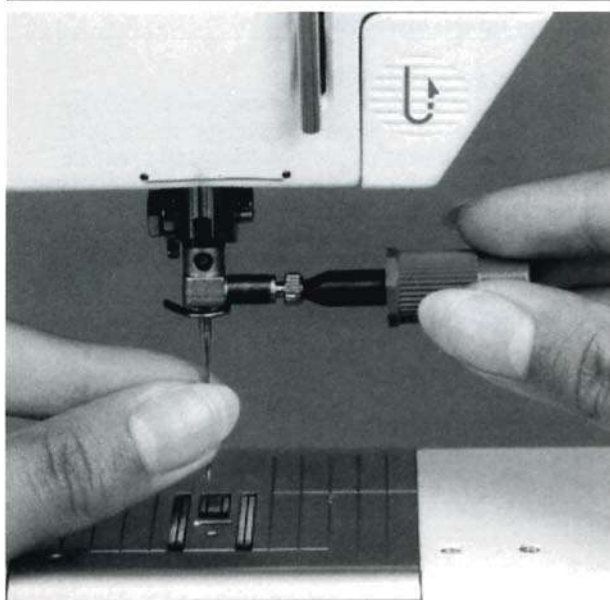

▲1

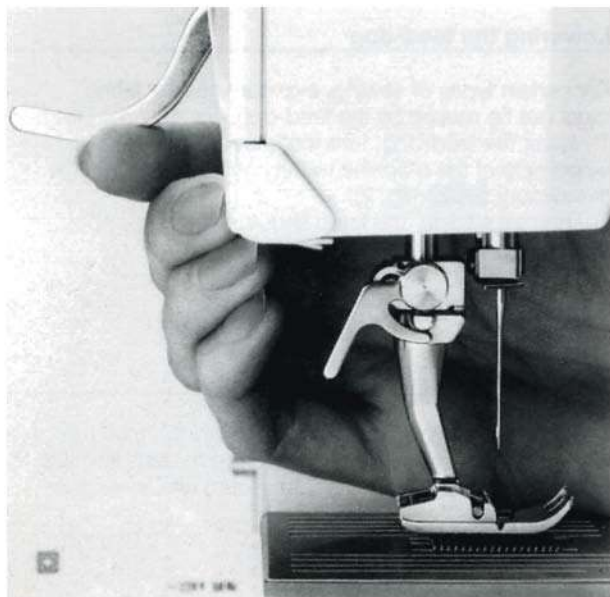

▲2

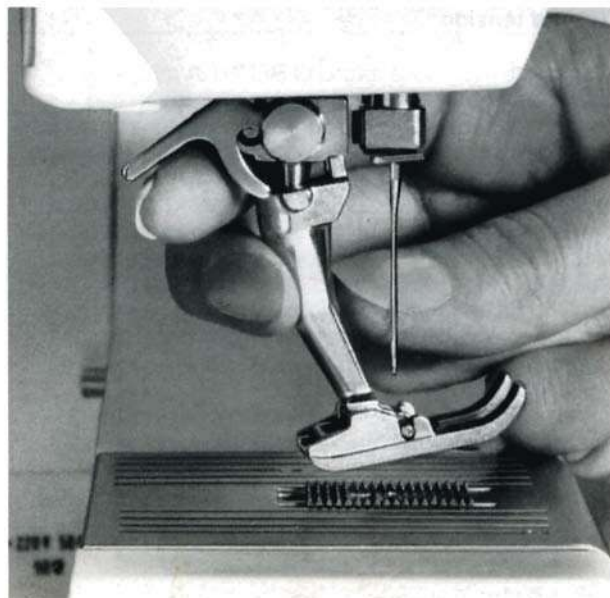

▼3

Inserting the needle

Use the small brown screwdriver provided in the accessory box to loosen or tighten the needle clamp.

Set the power switch to **0**. Check that the needle is raised. Lower the presser foot.

To insert the needle:
The flat side of the needle should always be to the back. Insert the needle until it reaches the top of the clamp. If the needle is not fully inserted, faulty stitches will occur.

Changing presser feet

A description of presser feet and their uses can be found on page 16.

Successful sewing depends on the correct choice of presser foot. The feet are very easy to change.

Turn the power switch to **0**

Check that the needle is raised.

Raise the presser foot (fig. 2).

Tighten the needle clamp securely.

To loosen the needle clamp, make a half-turn forwards (fig. 1).

WARNING:

Please refer to the safety instructions.

Raise the clamping lever with the index finger of the right hand and using the middle finger and thumb, remove the presser foot (fig. 3).

To attach the presser foot, the procedure is the same but press the clamping lever downwards with the index finger (fig. 4).

Turn the power switch to **1**

▼4

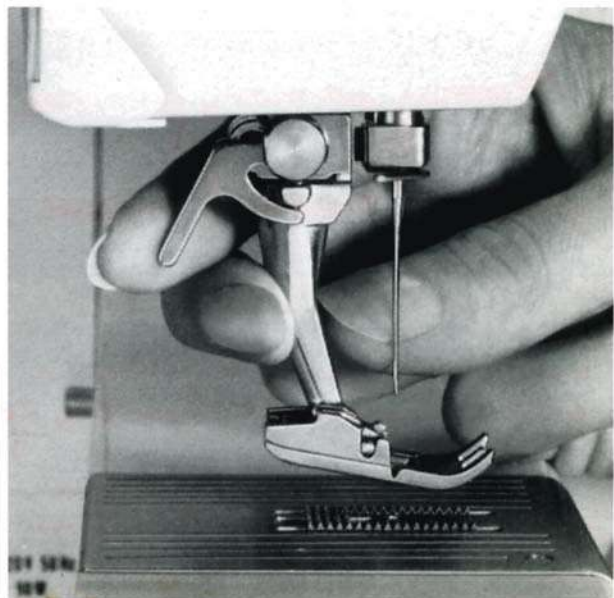

Menus
Presser feet
Practical stitches
Buttonholes

Menus

Main Menu

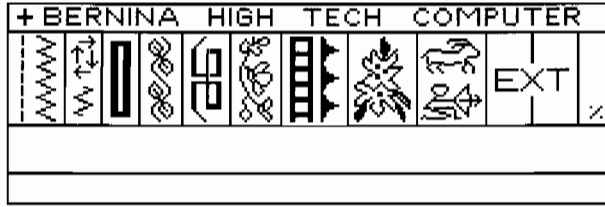

Menu 2

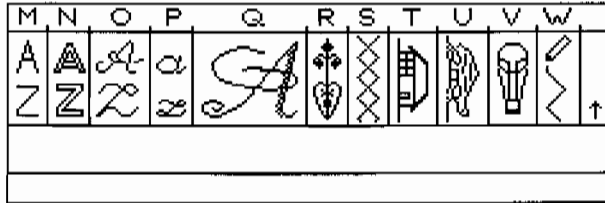

A1 Practical stitches 1

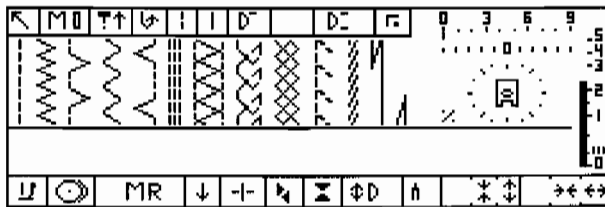

A2 Practical stitches 2

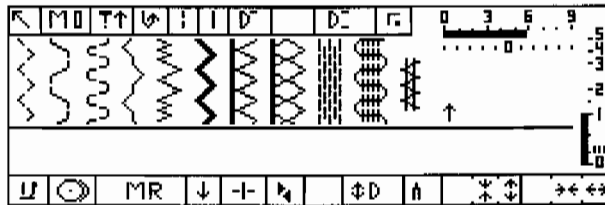

B1 Automatic mending programme with four directions

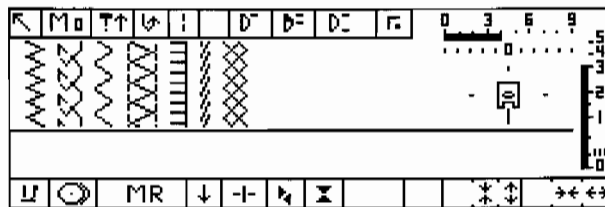

C1 Buttonholes / Eyelets / Button sewing-on

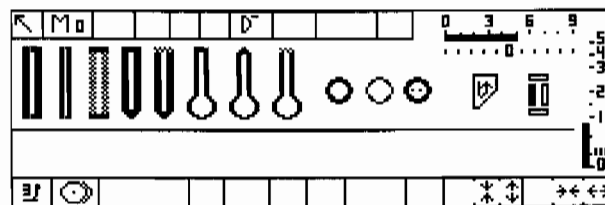

Menu 1

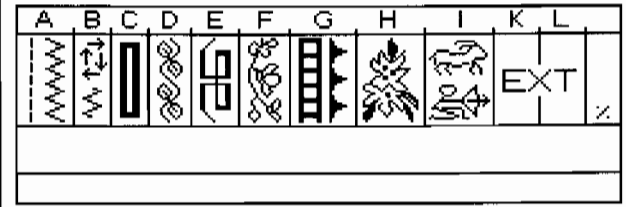

D1 Pearl stitches

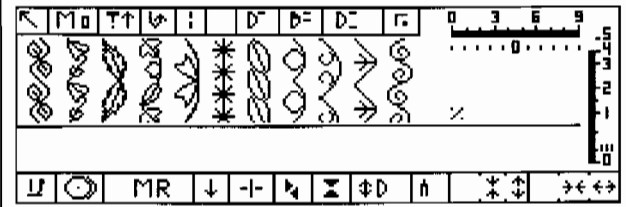

D2 Pearl stitches

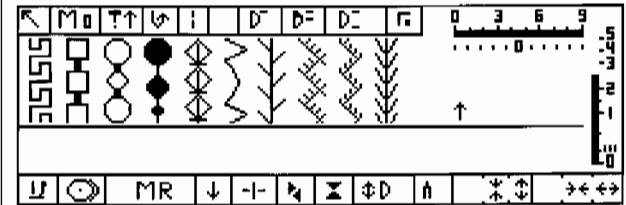

E1 Geometric patterns

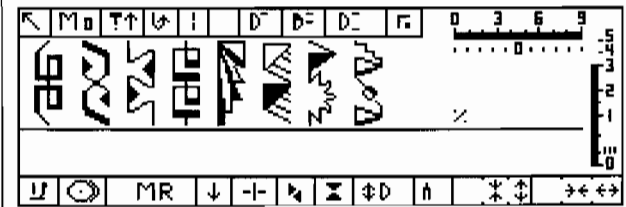

E2 Compact stitches

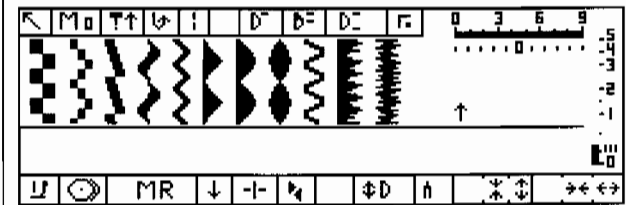

Balance

| 1 | 2 | 3 |
|----------|---|--------|
| Original | ↕ | ↓ ↑ |
| | | |
| | | |
| | | |
| | | |
| | | |
| | | |
| | | |
| | | |
| | | |
| | | |
| | | |

| 1 | 2 | 3 |
|----------|---|--------|
| Original | ↕ | ↓ ↑ |
| | | |
| | | |
| | | |
| | | |
| | | |
| | | |
| | | |
| | | |
| | | |
| | | |
| | | |

Balance

GB The first column shows how the pattern should look. If the sewn pattern looks like those in columns 2 and 3, the balance must be corrected as shown at the top of the table.

D Die Spalte 1 zeigt das Muster wie es korrekt aussehen soll. Sieht das genähte Muster aus wie in den Spalten 2 oder 3 dargestellt, muss mit der Balance-Richtung korrigiert werden, die am oberen Tabellenrand angegeben ist.

F La colonne 1 montre le motif tel qu'il doit paraître normalement. Si le motif cousu apparaît comme il est représenté dans la colonne 2 ou 3, il faut corriger avec la balance dans la direction indiquée en haut du tableau.

I La colonna 1 dimostra l'aspetto del motivo corretto. Se il motivo cucito ha l'aspetto del disegno dimostrato nella colonna 2 o 3 bisogna correggere il motivo tramite la funzione «Bilanciamento» indicata al margine superiore della tabella.

NL In de eerste kolom is het juiste motief afgebeeld. Indien het genaaide motief met de motieven in kolom 2 of 3 overeenkomt, moet de balans-richting worden aangepast. De juiste richting staat bovenaan de kolom vermeld.

S Första spalten visar hur mönstret skall se ut. Om det sydda mönstret ser ut som i spalt 2 och 3 måste balansen korrigeras såsom visas upptill i tabellen.

DK Spalte 1 viser mønstret som det skal se ud. Ser det syede mønster ud som vist i spalte 2 eller 3, skal der korrigeres med balance-retningen, som vist overst i tabellen.















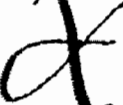





































SF Ensimmäinen kohta osoittaa millaiselta kuvion tulisi näyttää. Jos ommeltu kuvio on kuten kohdissa 2 ja 3, hienosäätöä tulee säätää taulukon yläosan ohjeen mukaan.

J 表中の最初の列には各縫い模様の標準の縫い目が表示されています。もし縫い目が表中の2列目、または3列目のようになる時は、表中の上段に示された方法で微調整を使って縫い目を整えます。

| 1 | 2 | 3 |
|----------|---|----|
| Original | ↕ | ↓↑ |
| A | A | A |
| B | B | B |
| C | C | C |
| D | D | D |
| E | E | E |
| F | F | F |
| G | G | G |

| 1 | 2 | 3 |
|----------|---|----|
| Original | ↕ | ↓↑ |
| H | H | H |
| I | I | I |
| J | J | J |
| K | K | K |
| L | L | L |
| M | M | M |
| N | N | N |

Balance

| 1 | 2 | 3 | 1 | 2 | 3 |
|---|---|---|---|--|---|
| Original | ↑↓ | ↓↑ | Original | ↑↓ | ↓↑ |
|  |  |  |  |  |  |
|  |  |  |  |  |  |
|  |  |  |  |  |  |
|  |  |  |  |  |  |
|  |  |  |  |  |  |
|  |  |  |  |  |  |
|  |  |  |  |  |  |
|  |  |  |  |  |  |
|  |  |  |  |  |  |

Balance



















GB The first column shows how the pattern should look. If the sewn pattern looks like those in columns 2 and 3, the balance must be corrected as shown at the top of the table.

D Die Spalte 1 zeigt das Muster wie es korrekt aussehen soll. Sieht das genähte Muster aus wie in den Spalten 2 oder 3 dargestellt, muss mit der Balance-Richtung korrigiert werden, die am oberen Tabellenrand angegeben ist.

F La colonne 1 montre le motif tel qu'il doit paraître normalement. Si le motif cousu apparaît comme il est représenté dans la colonne 2 ou 3, il faut corriger avec la balance dans la direction indiquée en haut du tableau.

I La colonna 1 dimostra l'aspetto del motivo corretto. Se il motivo cucito ha l'aspetto del disegno dimostrato nella colonna 2 o 3 bisogna correggere il motivo tramite la funzione «Bilanciamento» indicata al margine superiore della tabella.

NL In de eerste kolom is het juiste motief afgebeeld. Indien het genaaide motief met de motieven in kolom 2 of 3 overeenkomt, moet de balans-richting worden aangepast. De juiste richting staat bovenaan de kolom vermeld.



















| 1 | 2 | 3 |
|---|---|---|
| Original | ↑ ↓ | ↓ ↑ |
|  |  |  |
|  |  |  |
|  |  |  |
|  |  |  |
|  |  |  |
|  |  |  |

S Första spalten visar hur mönstret skall se ut. Om det sydda mönstret ser ut som i spalt 2 och 3 måste balansen korrigeras såsom visas upptill i tabellen.

DK Spalte 1 viser mønstret som det skal se ud. Ser det sydede mønster ud som vist i spalte 2 eller 3, skal der korrigeres med balance-retningen, som vist øverst i tabellen.

SF Ensimmäinen kohta osoittaa millaiselta kuvion tulisi näyttää. Jos ommeltu kuvio on kuten kohdissa 2 ja 3, hienosäätöä tulee säätää taulukon yläosan ohjeen mukaan.

J 表中の最初の列には各縫い模様の標準の縫い目が表示されています。もし縫い目が表中の2列目、または3列目のようになる時は、表中の上段に示された方法で微調整を使って縫い目を整えます。

| 1 | 2 | 3 |
|---|--|---|
| Original | ↑ ↓ | ↓ ↑ |
|  |  |  |
|  |  |  |
|  |  |  |
|  |  |  |
|  |  |  |
|  |  |  |
| | | |

BERNINA[®] 1630 *Inspiration plus*

UPDATE '96

The Best has just become ever better!

As the market leader, BERNINA pursues a strategy of continual product improvement to meet everchanging demands in the market. The new BERNINA 1630 UPDATE '96 shows the many benefits of such a strategy. Improvements include a wider choice of sideways motion stitches, the most popular quilting stitch, exciting new border and floral stitches and two new sizes of monograms.

- ✓ Quilting continues to grow in popularity. Therefore, the hand quilted stitch specially designed for use with monofilament thread is now available.
- ✓ Other stitches, for example cross stitches, have been improved. Although not visible on-screen, the improvements are clearly visible when sewn.
- ✓ The desire for more borders has been fulfilled and the little used "star signs" have been replaced by a larger selection of sideways motion floral motifs. These motifs can either be sewn individually or continuously to form wonderfully exciting borders.
- ✓ And even better still, the large monograms can now be sewn in three different sizes with 20 mm and 15 mm sizes sewn on a straight line being added to the standard 30 mm patterns.

The new **BERNINA 1630 UPDATE '96** offers creative opportunities truly over and above the norm. State-of-the-art electronic technology combined with sophisticated mechanics produce a stitch quality and selection unequalled anywhere. The BERNINA 1630 is a top performer which allows you to use your creative skills and sewing abilities to the fullest.

24 wonderful decorative stitches including 22 that can be used for exciting borders

H 1/5 + 1/6 (old)

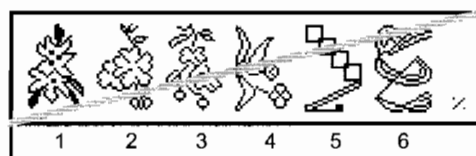

New: 2 Flower Sideways Motion Motifs

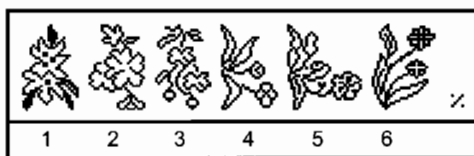

Menu I1 (old)

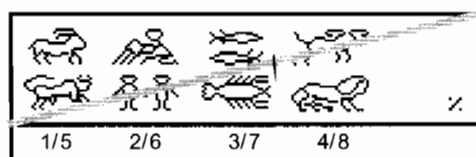

New: 7 Floral Sideways Motion Motifs



Menu I2 (old)

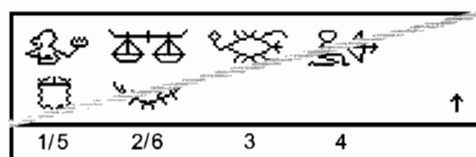

New: 7 Floral Floral Sideways Motion Motifs



Menu T1 (old)

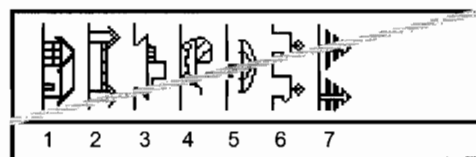

New: 7 Embroidery Stitches 9 mm

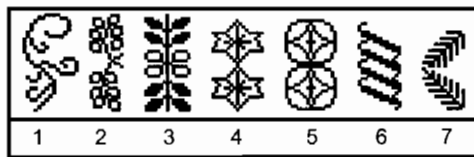

D 2/10 (old)

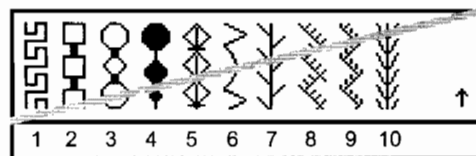

New: 1 Hand Quilted Stitch sewn with monofilament

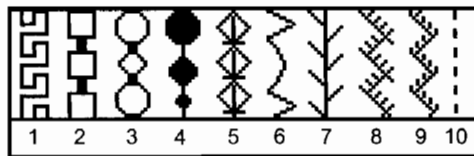

Instructions to Hand-look Quilting Stitch

To achieve an authentic looking hand quilt stitch in a fraction of the time it takes to sew it by hand follow these guidelines.

| | |
|----------------|---|
| Needle Thread: | invisible thread (monofilament) |
| Bobbin Thread: | Standard-polyester 100 or 120, or cotton 60 |
| Needle: | Standard or quilting size 90/14 |
| Stitch length: | As programmed |
| Tension: | Normal |

Tighten upper tension if necessary. For better stitching, slow machine to 1/3 speed.

Monograms now available in 3 different sizes

NEW: Menus Q1 and Q2

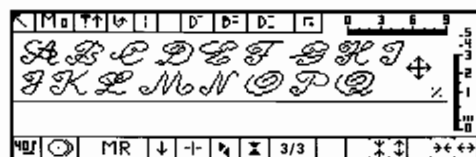

Monograms in 3 sizes

You can now sew monograms in three sizes. To select the size you want move the cursor to the bottom right hand panel on menus Q1 and Q2. Each time you click the display changes: 1/3 = 15mm, 2/3 = 20mm, 3/3 = 30mm

Use the templates to position the letters for the largest size. Sizes 15mm and 20mm are sewn on a line—each letter beginning bottom left and finishing bottom right. They can therefore be programmed into the memory and a set of initials can be sewn in one go without having to manually reposition the fabric.

Menus

N2 Double block alphabet

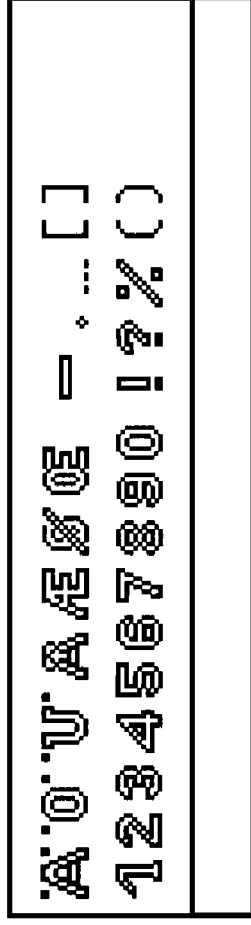

O1 Script (capitals)

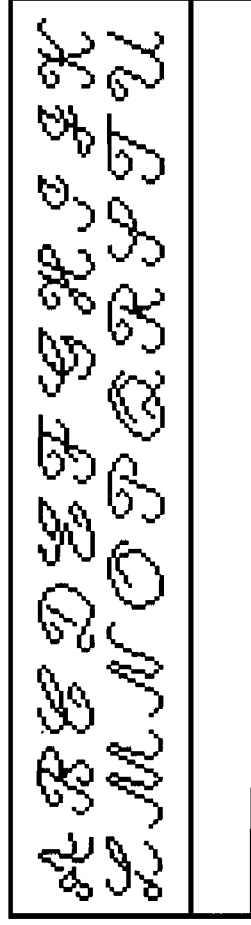

O2 Script (capitals)

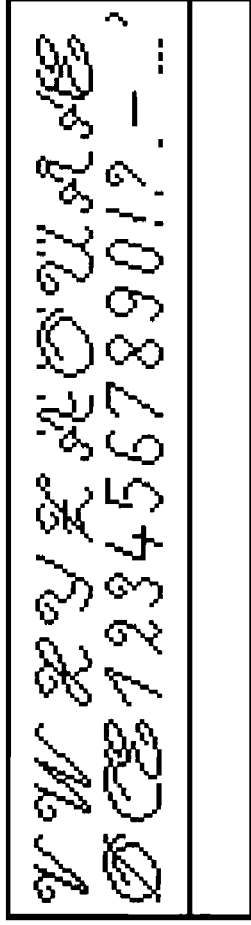

R2 Borders

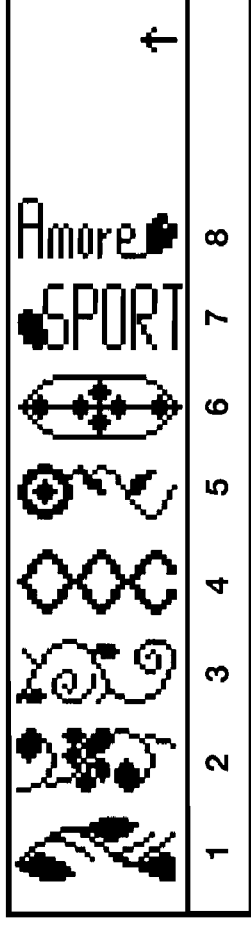

S1 Cross stitches

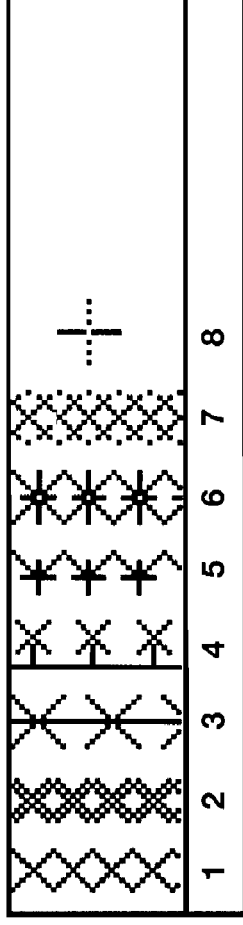

T1 Borders

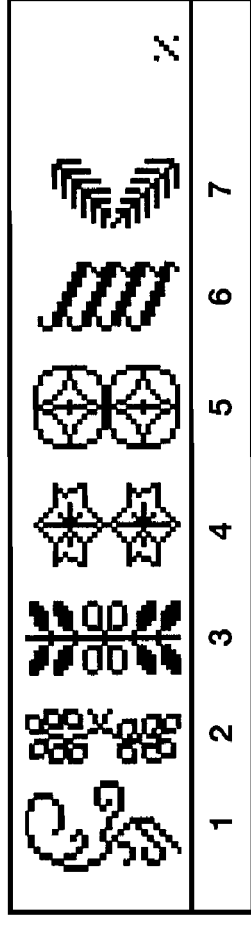

P1 Script (small letters)

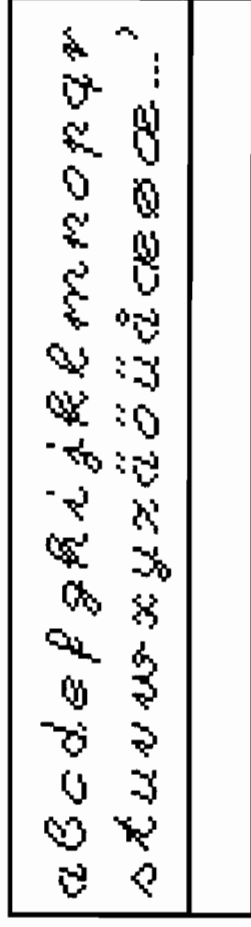

Q1 Monograms (sideways motion)

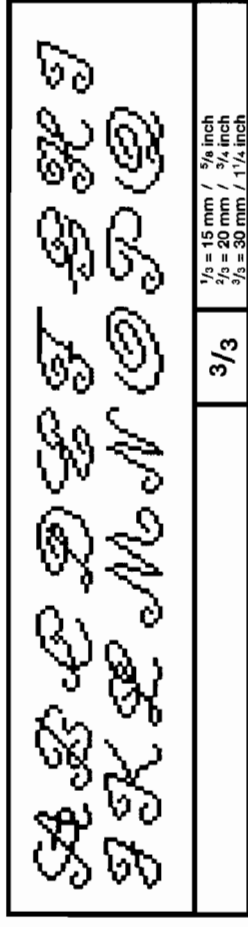

1/3 = 15 mm / 5/8 inch
 2/3 = 20 mm / 3/4 inch
 3/3 = 30 mm / 1 1/4 inch

Q2 Monograms (sideways motion)

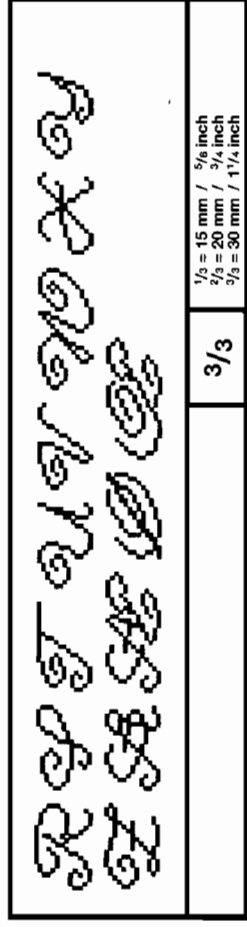

1/3 = 15 mm / 5/8 inch
 2/3 = 20 mm / 3/4 inch
 3/3 = 30 mm / 1 1/4 inch

R1 Borders

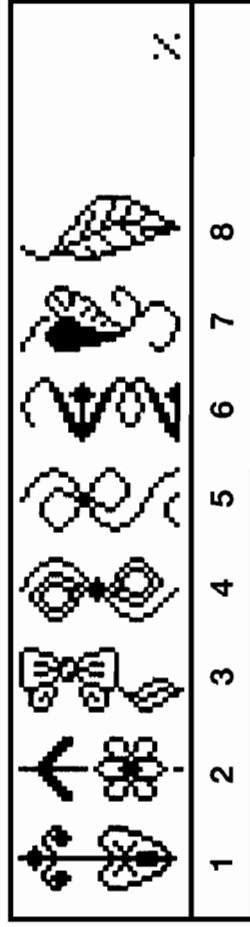

U1 Animals

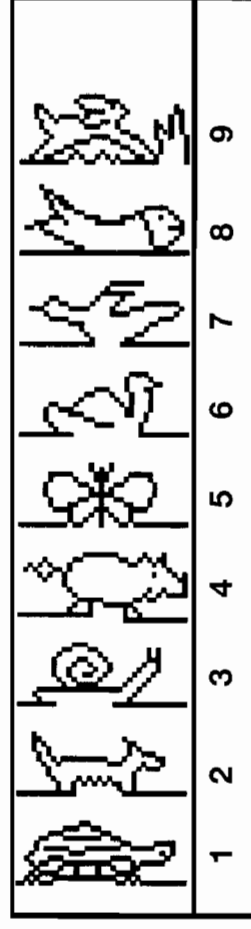

V1 Vehicles

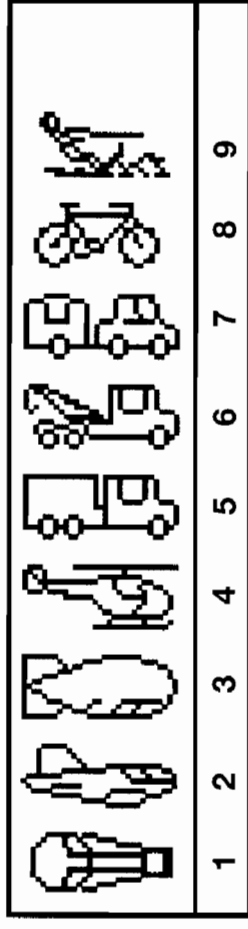

W1 Stitch designer (memory screen)

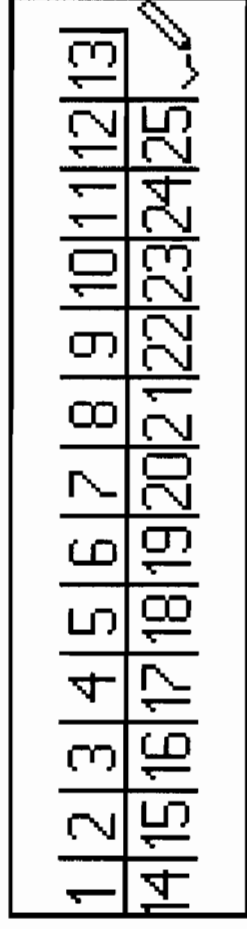

W2 Stitch designer (design screen)

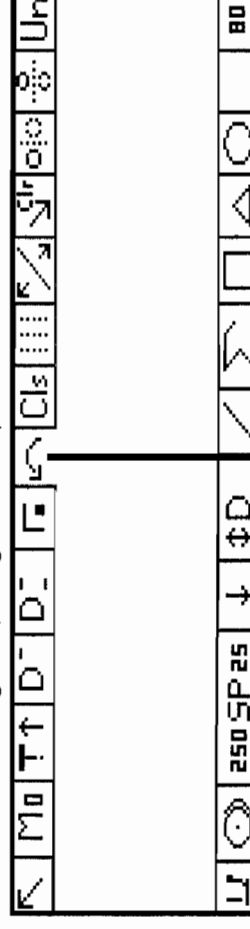

Menus

Menu 1

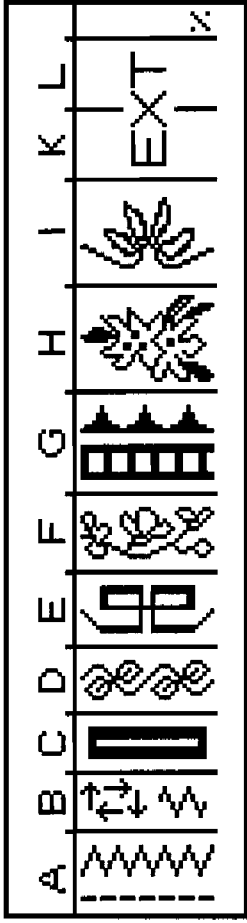

Menu 2

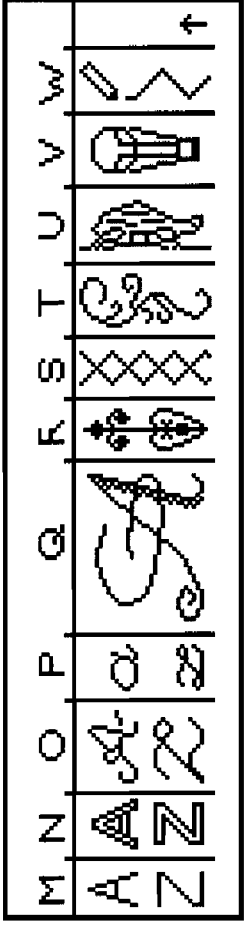

A1 Practical stitches 1

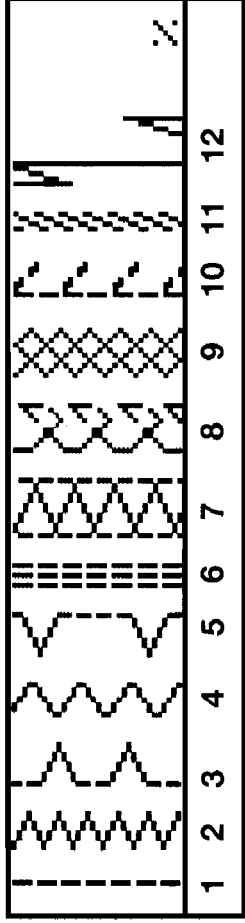

G1 Hem stitches / Edging stitches

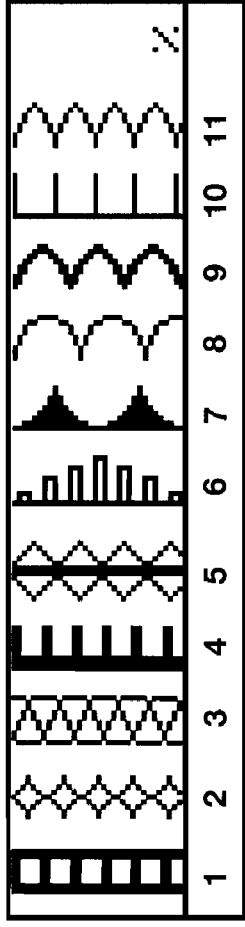

A2 Practical stitches 2

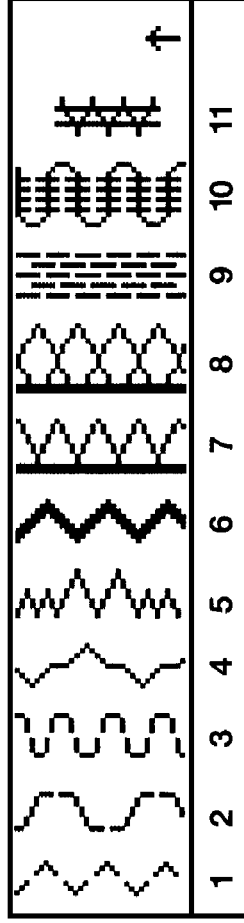

G2 Large edging stitches

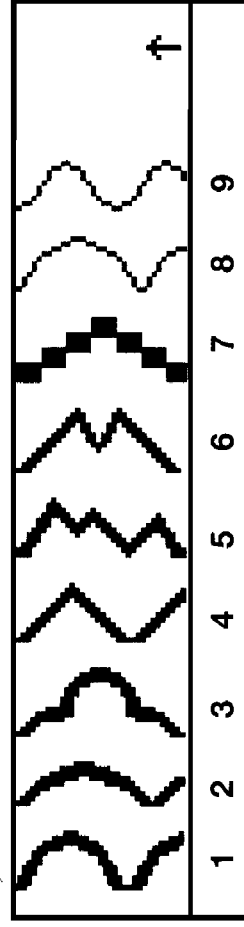

B1 Automatic mending programme with four directions

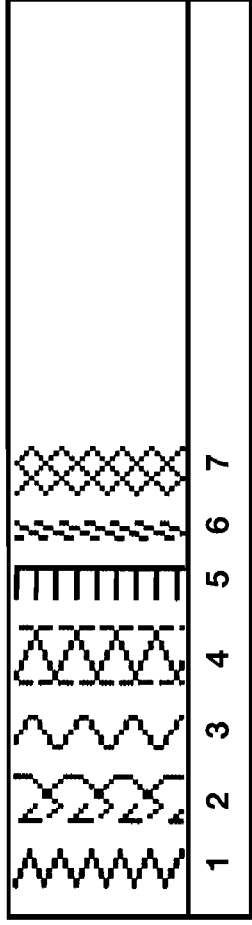

C1 Buttonholes / Eyelets / Button sewing-on

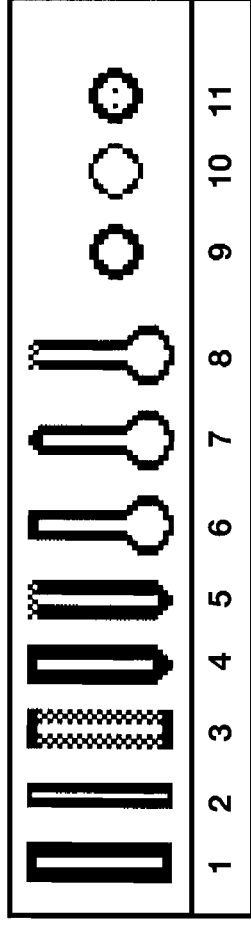

D1 Pearl stitches

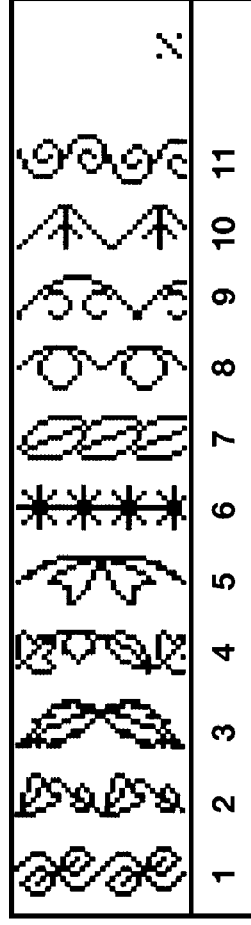

D2 Pearl stitches

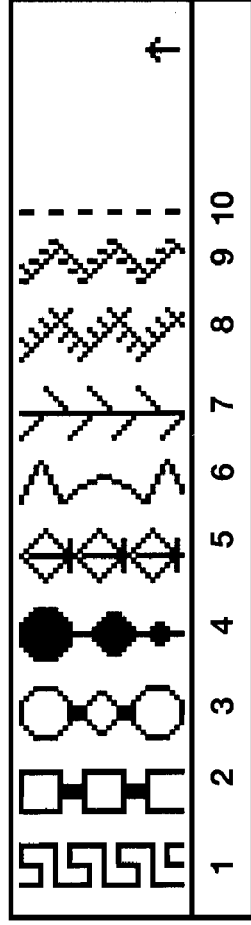

H1 Flowers (sideways motion)

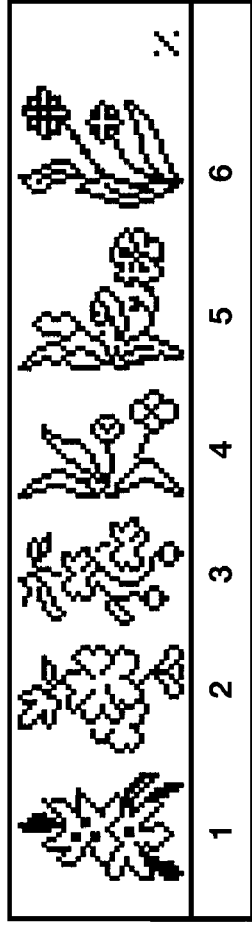

H2 Animals / trees (sideways motion)

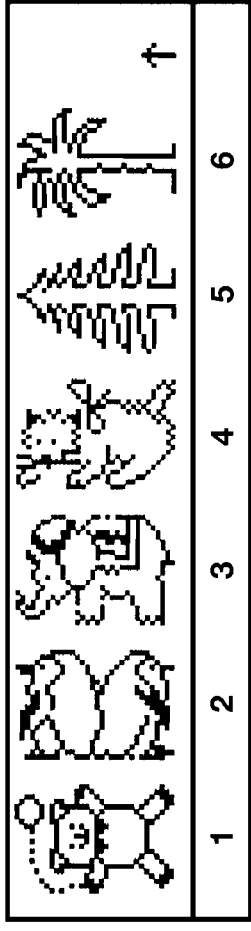

I1 Floral stitches (borders)

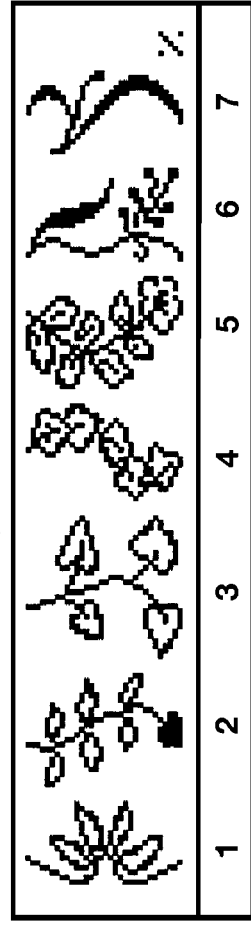

I2 Floral stitches (borders)

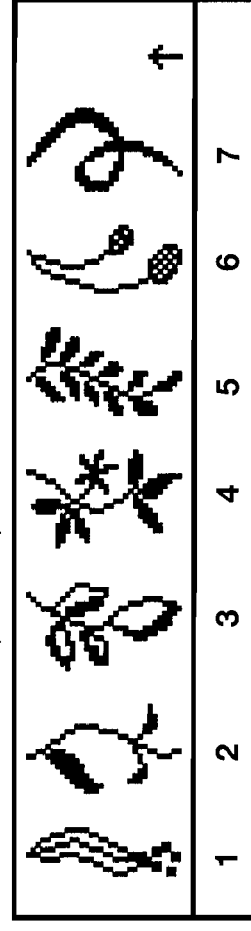

E1 Geometric patterns

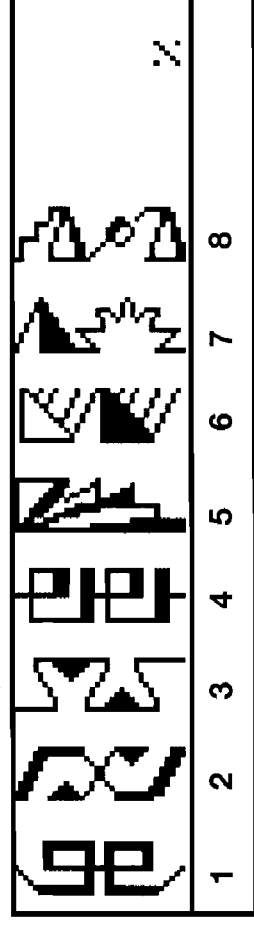

K1/L1 External memory socket (when connected)

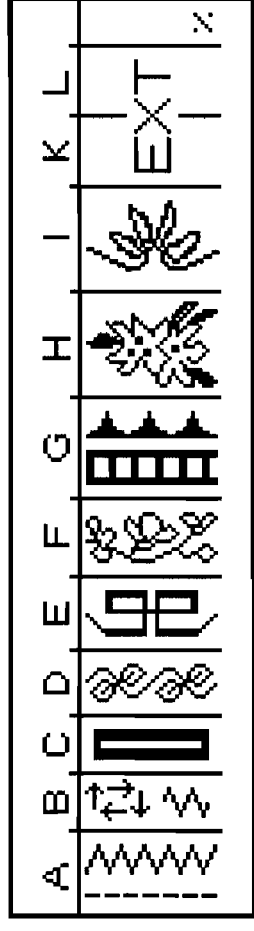

E2 Compact stitches

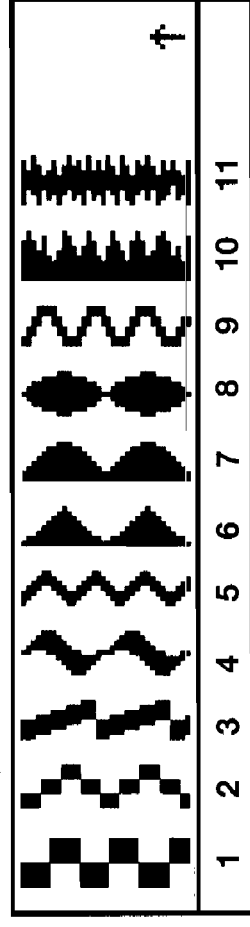

K1/L1 External memory socket (when connected)

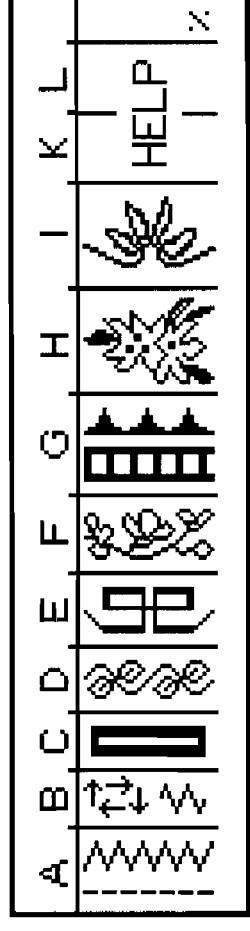

F1 Floral stitches

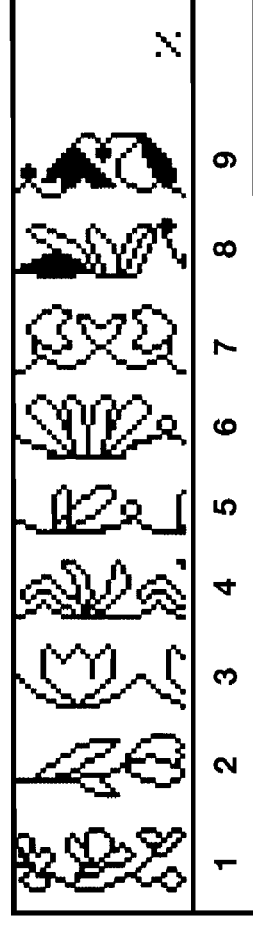

M1 Simple block alphabet

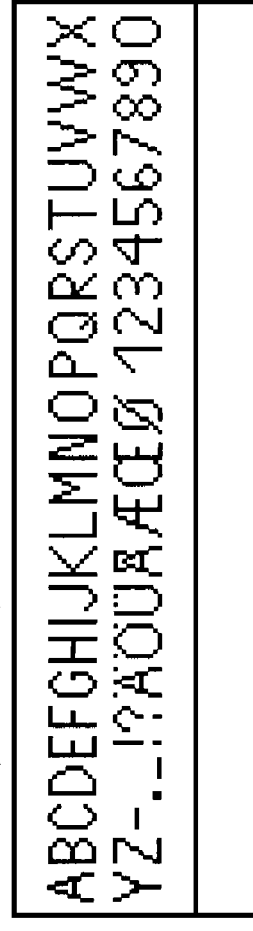

F2 Floral stitches

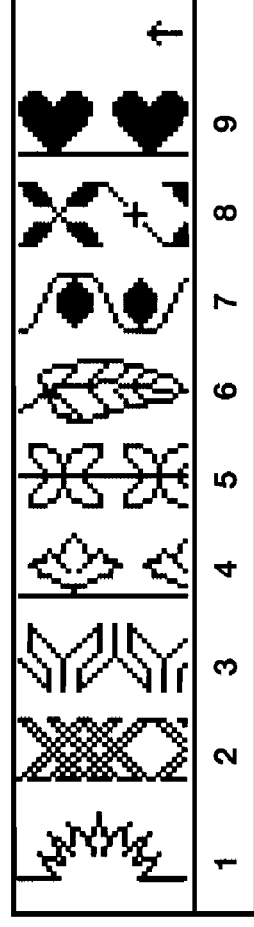

N1 Double block alphabet

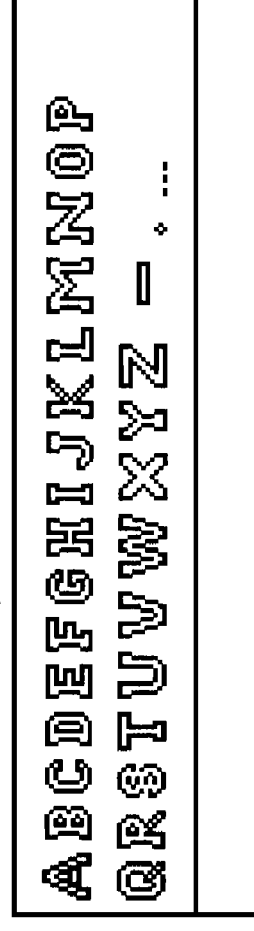

F1 Floral stitches

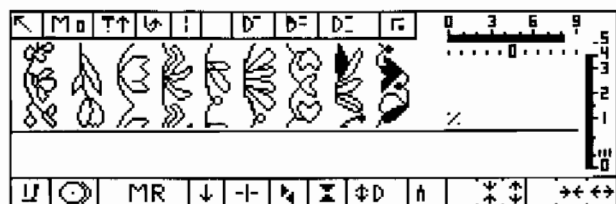

F2 Floral stitches

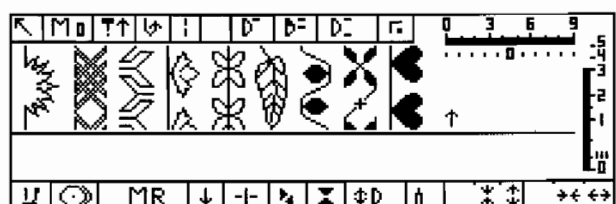

G1 Hem stitches / Edging stitches

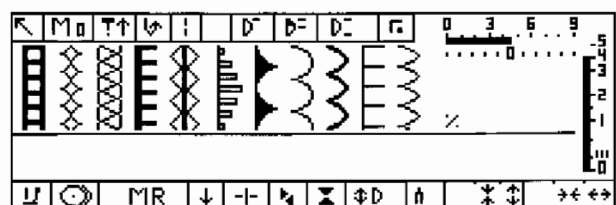

G2 Large edging stitches

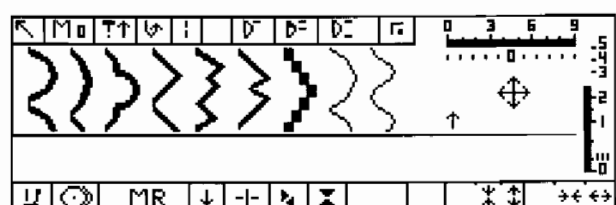

H1 Flowers (sideways motion)

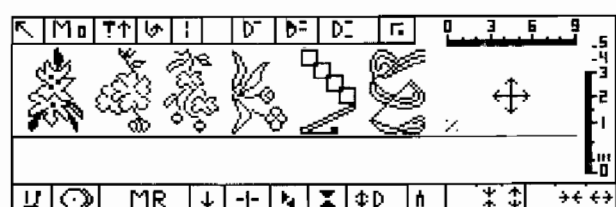

H2 Animals / trees (sideways motion)

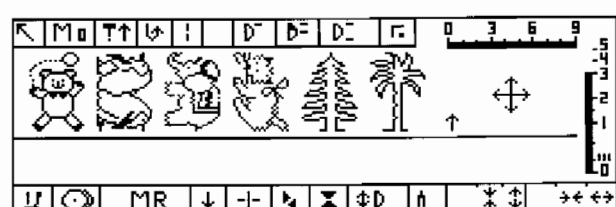

I1 Zodiac signs (sideways motion)

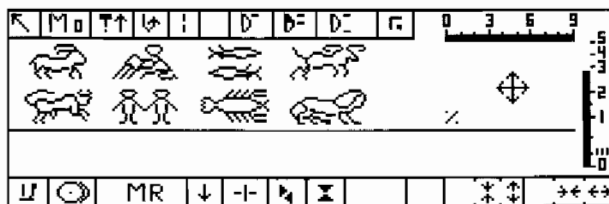

I2 Zodiac signs (sideways motion)

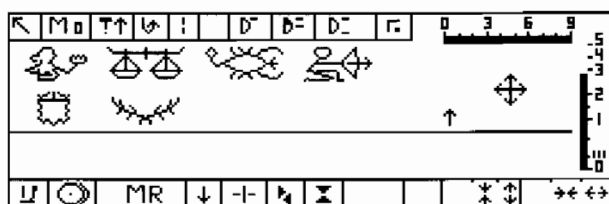

K1/L1 External memory socket (when disconnected)

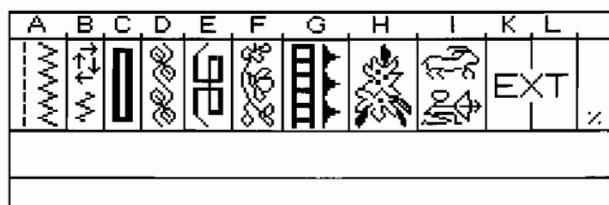

K1/L1 External memory socket (when connected)

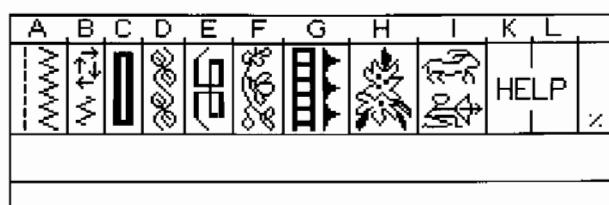

M1 Simple block alphabet

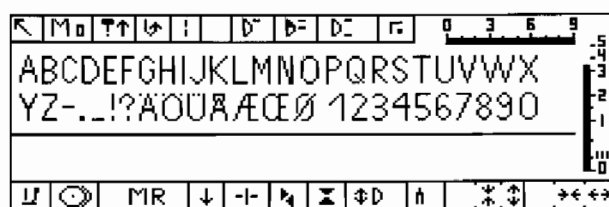

N1 Double block alphabet



N2 Double block alphabet

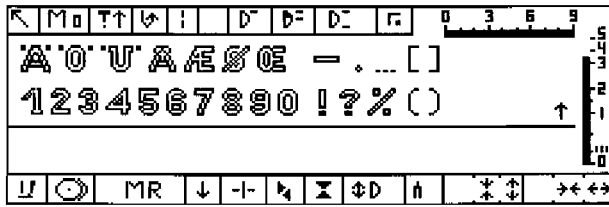

O1 Script (capitals)

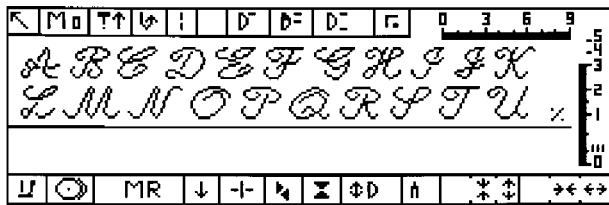

O2 Script (capitals)

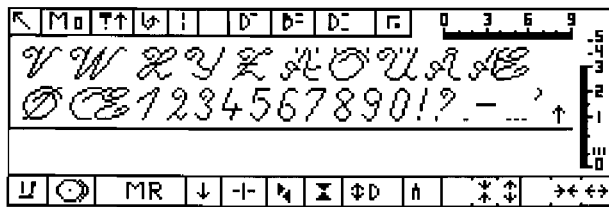

P1 Script (small letters)

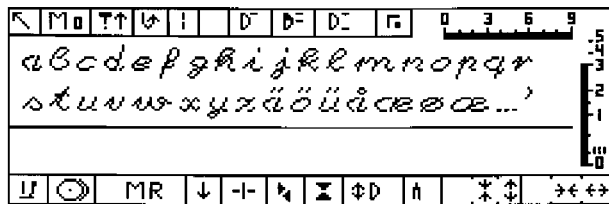

Q1 Monograms (sideways motion)



Q2 Monograms (sideways motion)

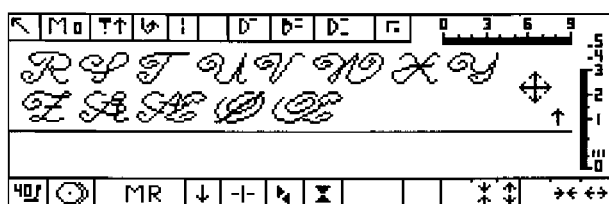

R1 Borders

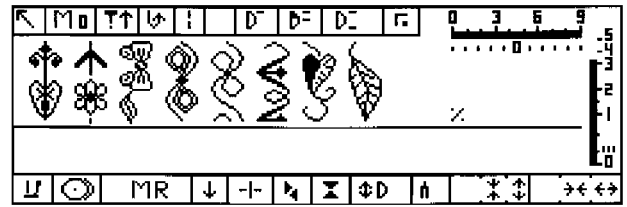

R2 Borders

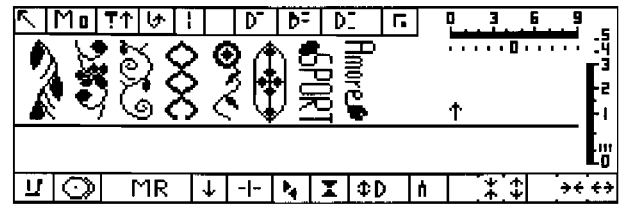

S1 Cross stitches

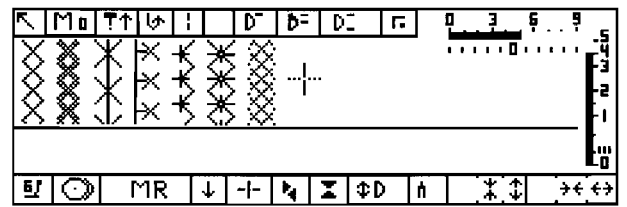

T1 Objects

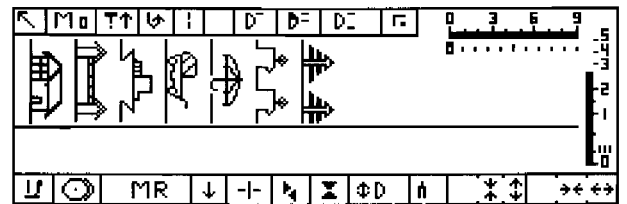

U1 Animals

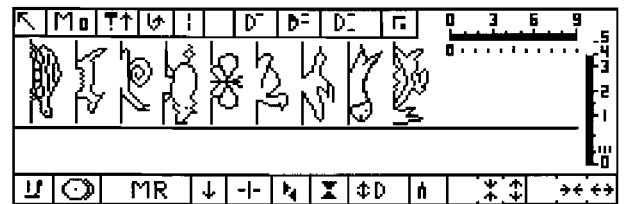

V1 Vehicles

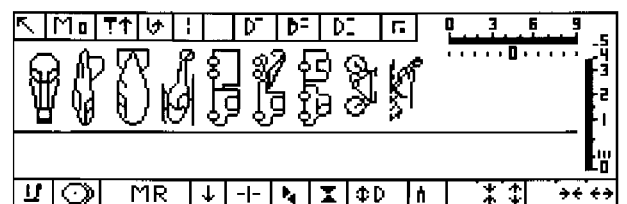

Presser feet

Presser feet are important sewing aids and are made with special grooves and guides to suit particular tasks. The success of a sewing project depends on the correct choice of presser foot.

Most of our presser feet are multi-purpose and can be used for several sewing tasks to produce successful results.

The new coded presser feet are intended for the 9 mm wide stitches. When using non-coded feet, the maximum width and needle positions are limited automatically.

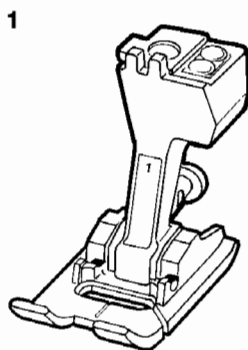

Coded reverse pattern foot

Practical stitches
Embroidery stitches

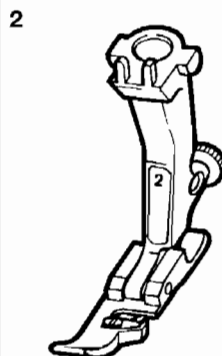

Overlock foot

Vari-overlock
Double overlock
Oversewing edges

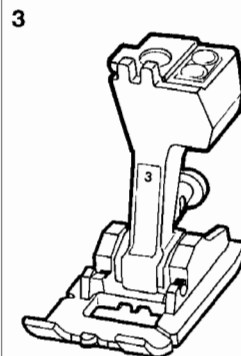

Coded buttonhole foot

Buttonholes

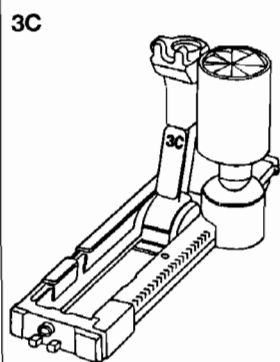

Automatic buttonhole foot

Buttonholes
Darning programme

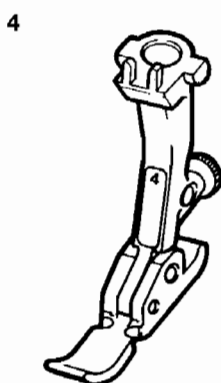

Zip foot

Sewing in zips
Top stitching raised seams

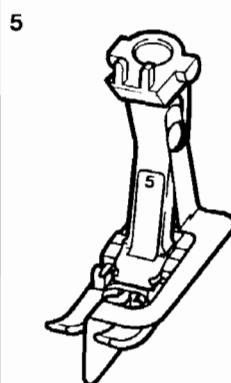

Blind Stitch foot

Blind hemming
Edge stitching

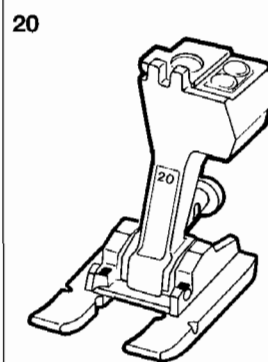

Coded open embroidery foot

Embroidery stitches
Satin stitch
Appliqué

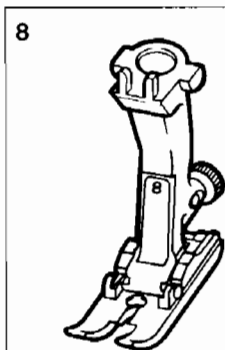

Jeans foot

Straight stitch in thick, hard fabrics and over several thicknesses.

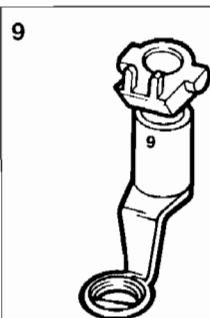

Darning foot

Darning
Quilting
Freehand monograms
Freehand embroidery



Button sewing on foot

Sewing on buttons

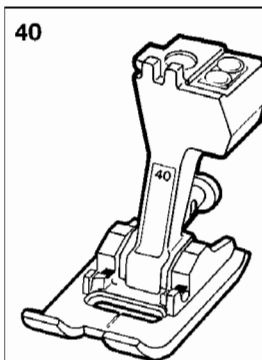

Coded sideways motion foot

For all sideways motion patterns

Practical stitches

A1/1 Straight stitch



All non-stretch fabrics. All straight stitch work.

A1/2 Zig-zag



Most fabric types. All simple zig-zag such as oversewing fine fabrics. Sewing on elastic and lace.

A1/3 Vari-overlock



Primarily for fine synthetic, silk and cotton jerseys. Stretch overlock seams and hems, particularly suitable for sports underwear, pyjamas, T-shirts, sweat-shirts, running suits, etc.

A1/4 Running stitch



Most types of fabric. Mending, patching, reinforced seams.

A1/5 Blind stitch



Most types of fabric. Blind hems, shell edging on soft jerseys and fine fabrics, decorative seams.

A1/6 Triple straight stitch



Corduroy, denim, canvas, tough, heavy fabrics. Bags, blankets, sleeping bags. Visible seams and hems. Sewing on tape.

A1/7 Double overlock



All types of knit. Hand or machine knitted fabrics. Overlock = sew and neaten in one operation.

A1/8 Jersey stitch



Natural, blended or synthetic fabrics. Visible seams and hems, particularly for lingerie, sweat-shirts and delicate knitted fabrics. Mending jersey/interlock. Sewing on elastic.

A1/9 Honeycomb stitch



Most types of interlock and smooth fabrics. Visible seams and hems in T-shirt, pullovers, lingerie, tablecloths, napkins, crafts.

A1/10 Stretch overlock



Medium weight knits, towelling and firm wovens. Overlock seam, flat joining seam, crafts.

A1/11 Super Stretch



Super stretch stitch for very stretchy fabrics. Ideal for sports and gymwear.

A1/12 Securing stitch



All types of fabric. Secures the beginning and end of seams sewn with straight stitch.

A2/1 Reinforced Zig-zag



Most types of fabric. Oversewing loosely woven fabrics, reinforcing edges, mending seams, sewing on elastic, decorative seams.

A2/2 Universal stitch



Firm interlock and knits such as fabrics such as felt and leather. Flat joining seams, visible seams, patchwork, mending interlock, sewing on elastic, decorative seams.

A2/3 Lycra stitch

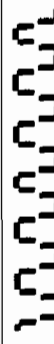

Special stitch for lycra. Flat joining seam and hems. Oversewing seams in underwear.

A2/4 Gathering stitch



Most types of fabric, including leather. Gathering with perle yarn or shirring elastic. Butted seams = butting two pressed edges and sewing together.

Practical stitches

A2/5 Stretch stitch

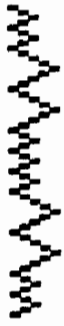

Very stretchy fabrics. Flexible and stretchy seam – ideal for sportswear.

A2/6 Triple zig-zag



Corduroy, denim, canvas, all thick and firm fabrics. Visible seams and hems. Sewing on tape.

A2/7 Reinforced overlock



Medium weight knits and jerseys, towelling and firm wovens. Overlock seam, flat joining seam, crafts.

A2/8 Knit overlock



All knits, including machine and hand knits. Overlock seam = sewing and neatening in one operation.

A2/9 Simple darning programme



Automatic darning in fine and medium-weight fabrics.

A2/10 Reinforced darning programme



Automatic darning in heavy-weight fabrics.

A2/11 Bartack programme



For reinforcing pocket corners, belt loops, etc.

Buttonholes

C1/1 Standard buttonhole



Fine to medium weight woven fabrics. Blouses, dresses, trousers, bedlinen, etc.

C1/2 Standard buttonhole narrow



Fine to medium weight woven fabrics. Blouses, dresses, trousers, children's and baby clothes.

C1/3 Stretch buttonhole



All stretch and knits – cotton, wool, silk and synthetic fabrics. Blouses, dresses, trousers, bedlinen, etc.

C1/4 Round buttonhole with normal bead



Medium to heavy weight fabrics. Dresses, jackets, coats, trousers, rainwear etc.

C1/5 Round buttonhole with diagonal bead



Medium to heavy weight fabrics. Dresses, jackets, coats, trousers, rainwear, etc.

C1/6 Keyhole buttonhole with normal bead



Heavy weight, non-stretch fabrics. Jackets, coats, trousers, leisure wear, etc.

C1/7 Keyhole buttonhole with pointed bead



Thick, firm non-stretch fabrics. Jackets, coats, trousers, leisure wear etc.

C1/8 Keyhole buttonhole with diagonal bead



Thick, firm non-stretch fabrics. Jackets, coats, trousers, leisure wear etc.

C1/9 Eyelet with narrow zig-zag



Opening for cords and narrow ribbons. Decorative effects on children's clothing, leisure wear, crafts.

C1/10 Eyelet with straight stitch



Opening for cords and narrow ribbons. Decorative effects on children's clothing, leisure wear, crafts.

C1/11 Button sewing-on programme



Sewing on buttons with 2 or 4 holes.

General Instructions Functions

General Instructions

The menus

Calling up

Switch the machine on with the power switch.

Main menu

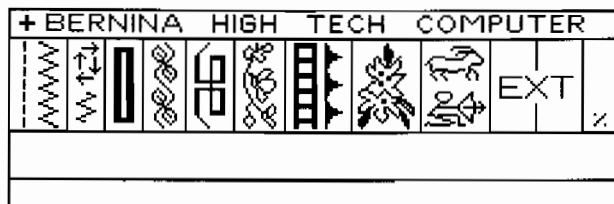

Press the OK button

Menu 1

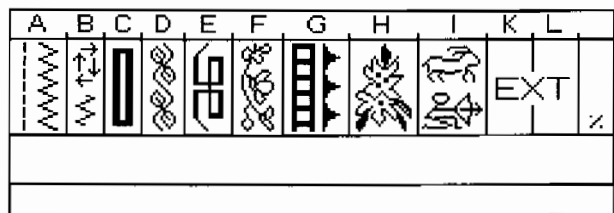

Move cursor to «Next screen» symbol (see «Functions» page 26) and press OK.
Or simply press CLR (cursor in any position on screen)

Menu 2

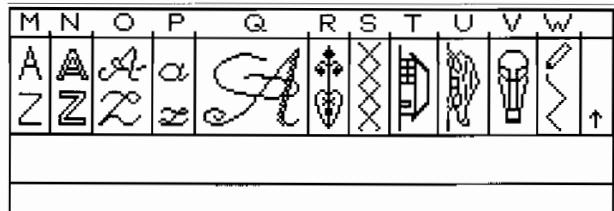

Return to menu 1:
Move cursor to «Previous screen» (see «Functions» page 26) and press OK.
Or simply press CLR (cursor in any position on screen)

Main menus

Menu 1

- A = practical stitches
- B = automatic mending programme with 4 sewing directions
- C = buttonholes / eyelets / button sewing-on
- D = pearl stitches
- E = geometric stitches
- F = floral stitches
- G = hem stitches / edge stitches (screen 2 sideways motion)
- H = flowers (sideways motion)
- I = zodiac signs (sideways motion)
- K = external memory (e.g. memory key)
- L = external memory (e.g. memory key)

Menu 2

- M = simple alphabet
- N = double alphabet
- O = script (capitals)
- P = script (small letters)
- Q = monograms
- R = borders
- S = cross stitches
- T = objects
- U = animals
- V = vehicles
- W = Stitch Designer

Controls



Cursor (on screen)

Command ball

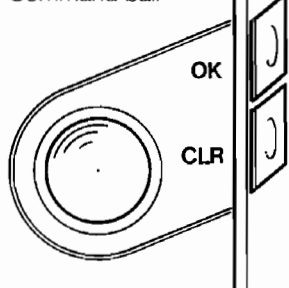

OK button

CLR button

From menu to stitch

The cursor is moved with the command ball to the position desired on the screen. Press the OK button to select the screen wanted. The first stitch on the screen is activated at the same time.

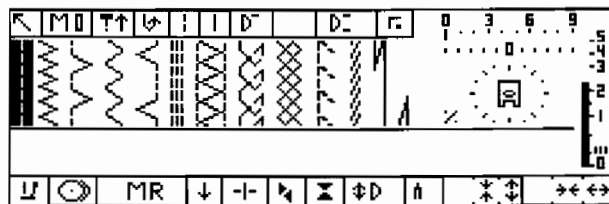

After switching on the machine is ready to sew straight stitch.

Procedure:

1. After switching on, the Main Menu appears on the screen.
2. Tap the foot control and stitch A1 is marked with the cursor and ready to sew.

Use the command ball to move the cursor to the stitch or function required.

Press OK to activate the selected stitch or function. The screen contrast inverts, i.e. the light sections become dark and the dark sections become light.

Special function numbers

Some special functions, e.g. Pattern End, have numbers which appear after being activated. The numbers can be selected by pressing OK (with the exception of the left number in the memory section – see «Programming»).

Cancelling a pattern/function

The selection and activation of a new stitch cancels the previously selected stitch.

Functions can be cancelled individually by moving the cursor to the appropriate symbol and pressing CLR.

Most functions and all altered stitch lengths/widths and needle positions can be cancelled by double-clicking CLR (press the CLR button twice quickly). (Exceptions: Needle stop, Double needle limitation.)

Stitch width / stitch length

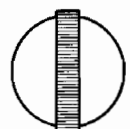
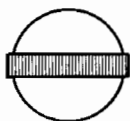
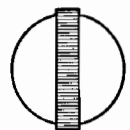
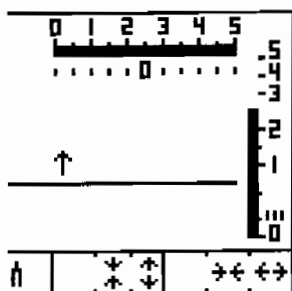
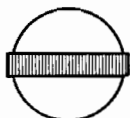
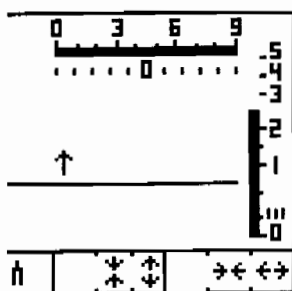

The stitch length and stitch width can be adjusted with the two dials. The basic settings remain visible.

A stitch width of 9 mm is possible with coded presser feet. The stitch width scale displays the numbers 0–9.

The stitch width for non-coded presser feet is 5 mm. The stitch width scale displays the numbers 0–5.

Restoring basic settings

1. After alteration, the basic settings can be reset by turning the dials manually.
2. The basic settings can be restored by double-clicking CLR. All altered functions will also be returned to their basic settings at the same time.

Needle positions



There is a choice of 11 needle positions.

To alter the needle position, move the cursor to the position required and press OK.

1. To return to the basic position manually, move the cursor to the basic position and press OK.
2. Double-click CLR. The needle position and all functions are returned to the basic setting at the same time.

Note:

When using non-coded presser feet, the needle positions are limited to the correct width for the foot.

Stitch identification

Patterns are not named on the screen. Each pattern is identified with a letter and two numbers.

Example: Stitch A1/4

A 1 4
Menu Screen Stitch



The letter indicates the menu, e.g. A, B, C, etc.

The first number indicates the screen in which the stitch is listed, e.g. 1 or 2.

The second number indicates the actual stitch. The stitches are numbered from left to right, e.g. no. 4 (Running stitch).

To select the second screen in a menu, select the first screen, e.g. A1. Then select the second screen by moving the cursor to the Next Screen symbol.

Programming/editing

Detailed instructions for programming and editing can be found in the section «Memory» on pages 56–59.

Memory key – external socket

The external socket for the memory key is on the right side of the machine.

When the key is inserted, new symbols appear in Menu 1 in K and L (EXT) which display the contents of the memory key.

The contents are selected in the same way as for all other menus and they can be saved in the usual way in the machine memory.

Note:

Only use BERNINA recommended appliances in the external socket!

Screen lighting/stand by

The screen is equipped with background lighting to ensure that all the information is easily visible.

If the machine is not used for a longer period of time while it is still switched on, the screen lighting turns off automatically after 3 minutes and the screen becomes darker. The information on the screen remains visible and the selected stitches or functions are not affected.

Restoring the lighting

The screen lighting is automatically restored as soon as any manipulation is made, e.g. moving the command ball or pressing any of the controls (OK or CLR, stitch length or width dials) or pressing the foot control.

Screen contrast setting

The contrast can be adjusted with the dial positioned above the handwheel (see No. 19 in Details of the Machine).

Functions

All functions are displayed in the top and bottom sections of the screen.

Selecting/activating the functions

Functions are selected by moving the cursor to the appropriate symbol and activated by pressing OK. As soon as the cursor is on a function symbol, it changes from a cross cursor to a marking cursor, covering the whole function section. It returns to a cross cursor as soon as it leaves the functions.

Functions with several numbers are selected by pressing OK until the desired function is reached, e.g. Pattern End, Memory, Pattern Extension, etc.

Cancelling functions

Individual functions:

Move the cursor to the appropriate symbol and press CLR.

All functions – return to basic settings:

Double-click CLR to erase all altered settings including stitch width, length and needle position.



The following functions must be cancelled individually: Needle Stop and Double Needle Limitation.

Functions

 **Menus**
After switching on the machine press OK.
Menu 1 (A,B,C) is activated.

 **Back to menu**
After selecting this function, the previous screen appears.

 **Sewing speed**
(1/3, 2/3 und 3/3)
The machine sews at the speed selected even when the foot control is fully depressed. The maximum speed can be limited for any stitch with the exception of sideways motion stitches. The speed selected appears on the screen.

 $1/3$  $2/3$  $3/3$

Applications: Difficult or intricate work, buttonholes, embroidery etc.

 **Needle stop up /down**
The Needle Stop can be altered to generally up or generally down. The arrow next to the needle symbol shows the setting.
Application: Sewing corners, difficult or intricate work, etc.

 **Reverse sewing**
Permanent reverse sewing.
Application: Mending with Running Stitch, inventing new embroidery stitches.

 **Long Stitch**
Only every 2nd stitch is sewn (max. stitch length 10 mm/3/8").
This function can be combined and programmed with stitches.
Application: Top stitching, decorative top stitching and basting fine fabrics.

 **Automatic Basting**
Only every 4th stitch is sewn (max. stitch length 20 mm/3/4").
Application: Basting

 **Pattern Begin**
Automatic return to the beginning of a pattern or pattern combination. The inverted display disappears after 2 seconds.
Application: Embroidery

 **1/2 Pattern**
The machine stops automatically at the halfway point of a pattern.
Application: Embroidering corners, combining patterns.

 **Pattern End 1-9x**
The machine stops automatically at the end of an individual stitch or programmed stitch combination.
Automatic stop at the end of a number of individual stitches or stitch combinations can be selected with the numbers 2-9.
Application: Motif embroidery and repeats.

 **Securing**
Three securing stitches are sewn automatically at the beginning and end of a single stitch, and at the beginning and end of stitch combinations saved in the Memory.
Application: Motif embroidery, individual or combined letters, etc.

 **Presser foot indicator**
The appropriate foot for each stitch selected is displayed.

 **Bobbin thread control**
The light-inverted symbol blinks when the bobbin thread is running low (approx. 2-5 m/yds, depending on the thickness). After rewinding the bobbin, move the cursor to the symbol and press OK. It stops blinking and normal lighting is restored.

 **Memory**
When Memory is selected, the free capacity is indicated on the left (max. 70 stitches/functions) and the selected Memory (1-9) on the right.
The next Memory is recalled by pressing OK and the contents are visible in the programming window.
Application: Programming and combining stitches.
Saved programmes can always be recalled (longterm memory).

 **Save/Leave Memory**
This function saves programmes and switches off the Memory.
In order not to lose saved programmes, it is essential to always leave the Memory with this function!

 **Memory subdivision**
The capacity in each memory can be subdivided into several sections, allowing efficient use of the 70 spaces.

 **Mirror image right-left**
The mirror image of the selected stitch will be sewn.
This function can also be programmed.
Application: Individual embroidery patterns or programming individual pattern combinations.

 **Mirror image vertical (sewing direction)**
The vertical (sewing direction) mirror image of the selected stitch will be sewn.
This function can also be programmed.
Application: Individual embroidery patterns or programming individual pattern combinations.

 **Pattern Extension 2-5x**
Individual stitch or programmed stitch combinations can be lengthened.
Depending on the stitch formation, they can be lengthened up to 2 to 5 times.
This function can be combined and saved together with stitches.
Application: Embroidery of all types.



Double Needle Limitation 2–4 mm

The stitch width is limited.
By pressing OK, the Double needle width will be indicated (2, 3, or 4 mm) and the stitch width limited accordingly.
To cancel the Double Needle Limitation, press OK.
Application: Sewing with Double needles.

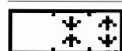

Vertical balance

For balancing forwards and reverse feed stitches and for altering the length of sideways motion stitches.
Shortening (max. 50 steps)
Lengthening (max. 50 steps)
Application: Practical stitches, e.g. Honeycomb stitch in jersey, decorative stitches, fantasy stitches, letters and buttonholes, etc.

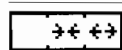

Horizontal balance

For altering the width of sideways motion stitches.
Narrowing (max. 20 steps)
Widening (max. 20 steps)
Application: Sideways motion stitches

The following function symbols appear to the right of the last stitch on the screen. They indicate that there is more than one screen in the same menu, e.g. A1 and A2, or that the selected stitch can be sewn in more than one direction.



Next screen

Press for the next screen within a menu.



Previous screen

Press for the previous screen within a menu.



16 sewing directions

16 directional sewing can be done with straight and zig-zag stitches.
Application: To sew in all directions on tubular items, to move individual patterns in any direction (see pages 60–62 for examples).

Additional symbols in some screens

The following symbols appear when certain stitches are selected.

They remind you about manipulations which must be carried out when sewing certain stitches.



Securing button on head frame

This button memorises the length of buttonholes; mending and darning programmes are also saved with this button. The desired length is sewn and then memorised by pressing the Securing Button.



Turn fabric

This symbol appears half way through the last cross stitch in the Cross Stitch screen (M1/8) to remind you to turn the fabric by 90 degrees.



Sideways motion stitches

The stitches in this menu are sewn vertically and horizontally.

Practical Sewing

Straight stitch, needle positions

Straight stitch forwards

Needle: 80-90

Thread:

Sewing/darning thread

Feed-dog: 

● Stitch: A1/1

Straight stitch

Select Menu A1, straight stitch is activated (stitch 1). The basic settings are displayed on the stitch length scale.

Adjusting the stitch length

Adjust the length to suit the fabric with the stitch length dial. The basic setting remains visible.

To restore the basic setting, double-click CLR.

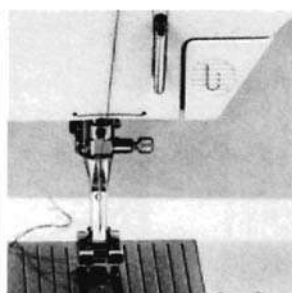

▲1

Securing

(Seam begin / seam end)
There are two methods:

Securing using the Securing Button on the frame head

Press the button. The machine sews in reverse until the desired number of stitches have been sewn. Then release the button and the machine sews forwards (fig. 1).

Securing using stitch A1/12 (straight stitch)

When this stitch is activated, the machine sews 5 forward and 5 reverse stitches. Then it goes into the forward mode again and the seam can be completed.

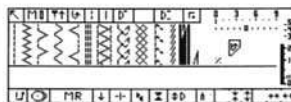

This procedure can be reversed by pressing the Securing Button on the head frame. The machine sews 5 reverse, 5 forward stitches and then stops.

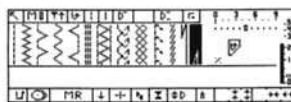

The Securing Function

When this function is selected, 3 securing stitches will be sewn on the spot at the beginning and end of individual stitches.

If a stitch or letter combination is programmed, the securing stitches are sewn at the beginning and end of the combination.

This securing function is particularly useful for individual embroidery stitches/letters or at the beginning and end of a stitch combination / word.

Needle positions

The needle position is altered with the cursor and OK (Page 23).

Example: Edge stitching (Page 30), sewing in zips (Page 35)

For normal sewing, the needle position is Centre.

Zig-zag

Needle: 80-90

Thread:

Sewing/darning thread

Feed-dog: 

Stitch: A1/2

Zig-zag

Max. stitch width 5.5 mm

Select Zig-zag (A1/2) and activate. The basic width and length settings are indicated on the scales.

Adjusting the stitch width

Use the stitch width dial to adjust the width to suit the fabric and work.

The width of all stitches can be adjusted while sewing. To restore the basic setting, double-click CLR.

Neatening edges

Needle: 80-70

Thread: Darning thread

Feed-dog: 

If necessary, adjust the width and length to suit the fabric. In general, the zig-zag should not be too wide or too long. Use as fine a thread as possible, especially on fine fabric. Trim the raw edges. Guide the edge of the fabric to the centre of the foot so that the needle goes into the fabric and then over the edge.

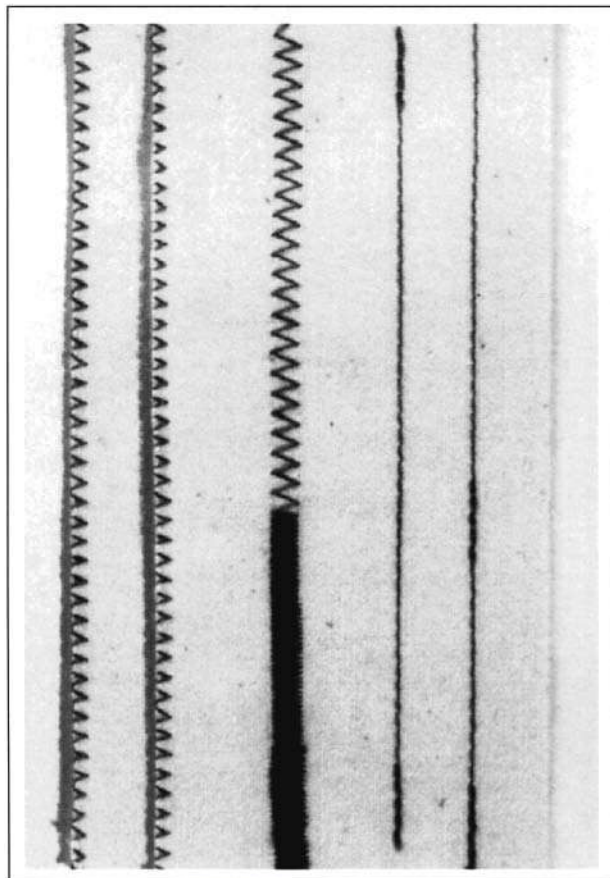

Straight stitch, needle positions

Individual programming – altering basic settings

Satin stitch = close zig-zag

Select zig-zag. Adjust width as required and set length to satin stitch (symbol on stitch length scale). Test sew!

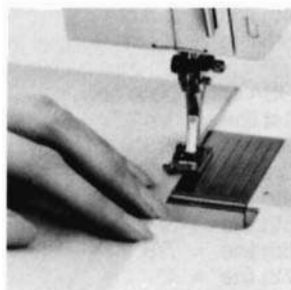

Individual programming

Individual stitch length and width settings can be saved even if other stitches are sewn in between. This is particularly useful for basic stitches such as straight and zig-zag.

When altered stitch width and length settings are recalled and sewn, you must use the same foot as you used when the alterations were made.

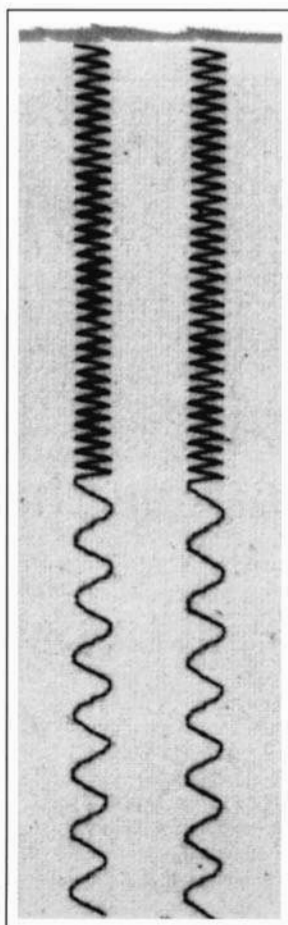

Example

Needle: 80–90

Thread:

Sewing/darning thread

Feed-dog:

Stitch: A1/2

and A1/4

Zig-zag

Running stitch

1. Select Zig-zag, adjust width to 4 and length to 1.
2. Select Running stitch (A1/4), adjust width to 4, length to 1.
3. Select Zig-zag and the altered settings appear.
4. Select Running stitch and the altered settings appear.

The altered settings will be saved. They remain saved until the basic settings are restored or until the machine is switched off.

Restoring basic settings

There are two methods:
– Manually.
– Double-click CLR. This clears all altered settings.

Altering basic settings

The width and length of all stitches can be altered to suit the fabric and the work.

Edge stitching

Collars, cuffs, lapels, hems, etc.

Narrow edge stitching

Needle: 80-90

Thread: Sewing thread

Feed-dog: 

● Stitch: A1/1

Straight stitch

Stitch length as required.

Needle position:

Left for outer edges.

Needle position:

Right for turned edges

Presser foot:

No. 5 Blind Stitch foot

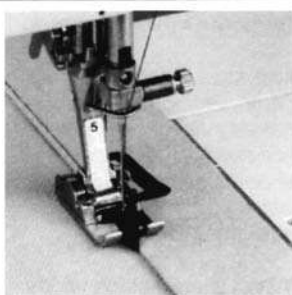

▲2

Turned edges

From the right, place the turned edge against the guide on the foot and select needle position right (fig. 2).

Wide edge stitching

For all edges.

Needle: 80-90

Thread: Sewing thread

Feed-dog: 

● Stitch: A1/1

Straight stitch

Needle position:

any position

Guide the fabric edge along the presser foot (fig. 3) or one of the lines on the stitch plate. The needles positions can be used for sewing intermediate widths.

Widths:

Presser foot width =

1 cm/3/8" (coded feet)

7.5 mm/1/4" (non-coded feet)

Stitch plate lines:

1st line = 1 cm

2nd line = 1.5 cm

3rd line = 2 cm

4th line = 2.5 cm

5th line = 3 cm

USA stitch plate only:

1st line = 1/4"

2nd line = 3/8"

3rd line = 1/2"

4th line = 5/8"

5th line = 3/4"

6th line = 7/8"

7th line = 1"

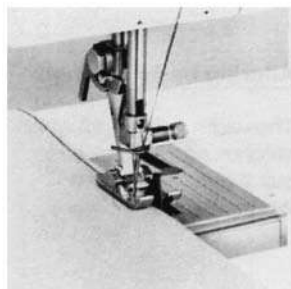

▲1

Outer edges

From the left, place the edge of the fabric against the guide on the Blind Stitch foot, set needle position left to the required distance from the edge (fig. 1).

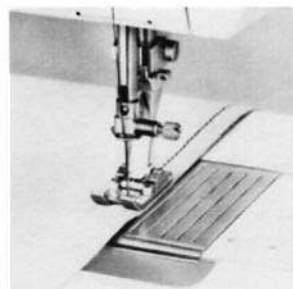
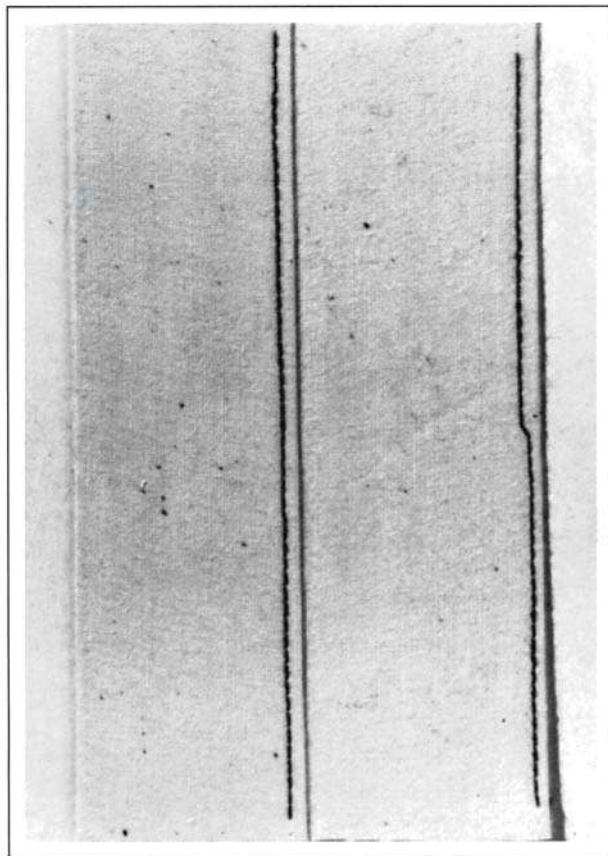

▲3

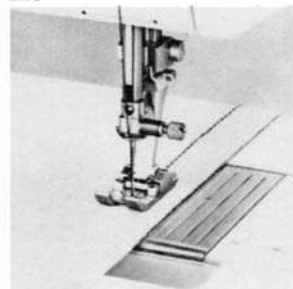

▲4

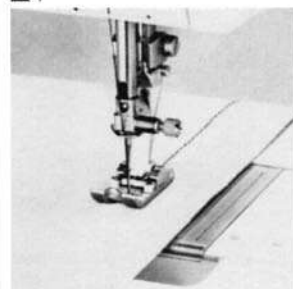

▲5

Practical stitch seams

The choice of seam depends on the item to be sewn, the choice of stitch on the fabric. There are 3 types of seams:

Open seams

Seams which are pressed open. They lie flat and can be let out.
Applications: trousers, skirts, coats, jackets, etc.

Overlock seams

Seams which are sewn and neatened in one operation.
Applications: in knits for pullovers, jackets, jersey blouses, underwear, hand and machine knitted garments.

Flat joining seams

Seams in which the fabric edges are overlapped and oversewn.
Applications: leisure wear, underwear, crafts.

Triple straight stitch seam

Open seam.

Hard wearing seam for firm woven fabrics, e.g. for trousers.

Needle: 80–90

Thread: Sewing thread

Feed-dog: 

● Stitch: A1/6



Triple straight stitch

Zig-zag seam

Open seam.

Stretch seams for interlock fabrics in wool, synthetic or blended fibres, and for silk, cotton and wool jersey.

Needle: 80

Thread: Sewing thread

Feed-dog: 

● Stitch: A1/2



Zig-zag

Max. stitch width: 5.5 mm

Stitch width approx. 1

Stitch length approx. 1 1/2

Stretch seams

Super stretch seams

Open seam.

Very stretchy seam for stretch fabrics; ideal for sportswear.

Needle: 80

Thread: Sewing thread

Feed-dog: 

● Stitch: A1/11 or A2/5

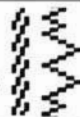

Super Stretch stitch
Stretch stitch

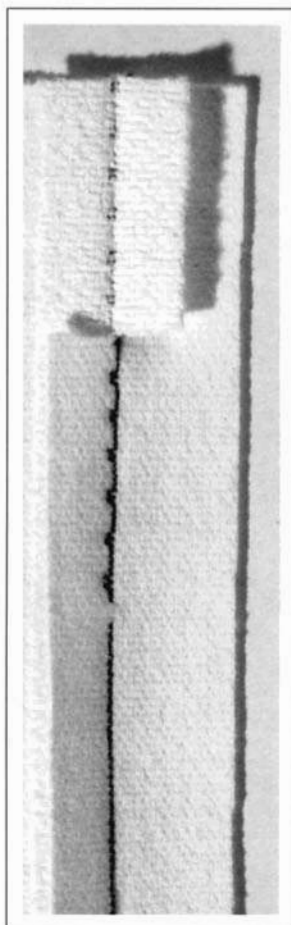
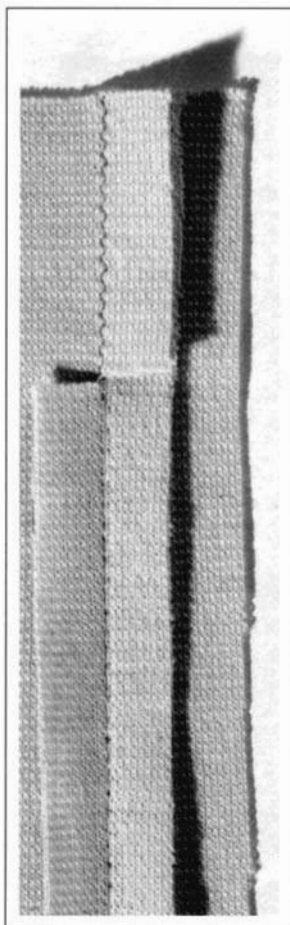
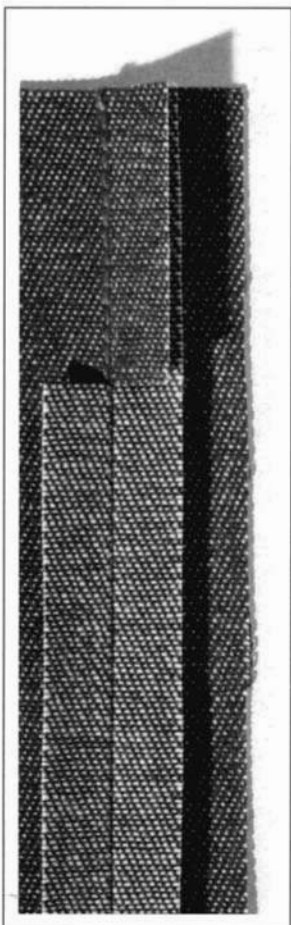

Practical stitch seams

Vari-overlock seam

Stretch overlock seam for all fine, soft knits, e.g. silk jersey, fine interlock, etc.

Needle: 80-70

Thread:

Sewing thread/
darning thread

Feed-dog: 

● Stitch: A1/3



Vari-Overlock

Position the fabric edge under foot so that it is in line with the pin on the foot.

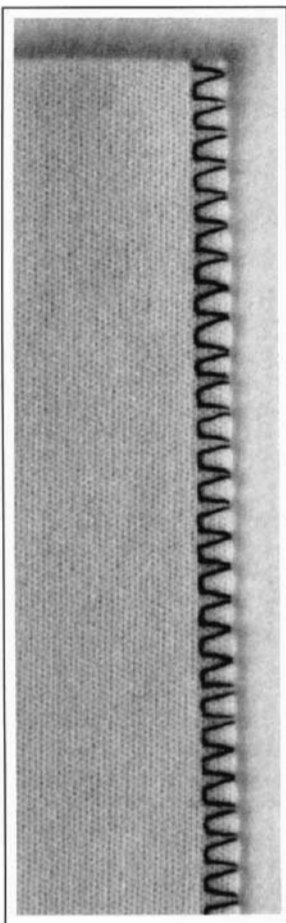
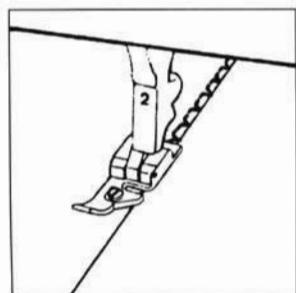

Double overlock seam

Knit overlock seam

Overlock seam for loosely woven knits.

Needle: 80

Thread: Sewing thread

Feed-dog: 

● Stitch: A1/7
and A2/8

Double overlock

Knit overlock

Max. stitch width:
Double overlock 5.5 mm

Knit overlock 6 mm

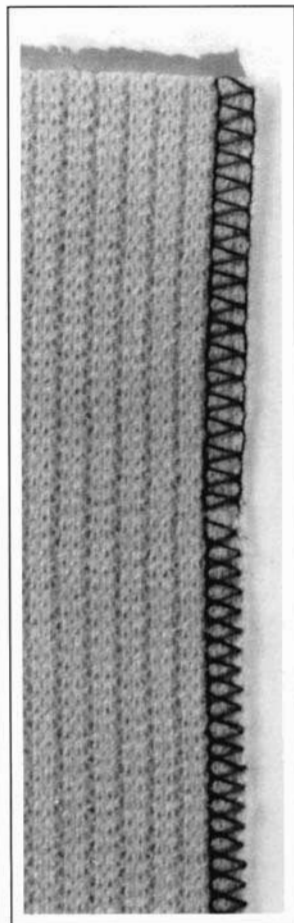

Stretch overlock seam

Reinforced overlock seam

Overlock seam for firm, thicker knits.

Needle: 80

Thread: Sewing thread

Feed-dog: 

● Stitch: A1/10
or A2/7

Stretch overlock

Reinforced

overlock

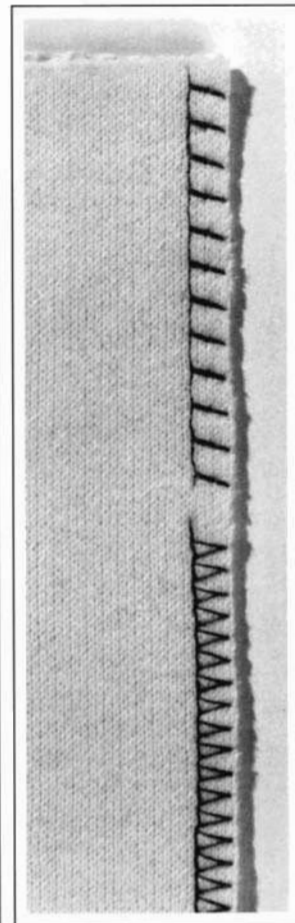
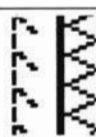

Practical stitch hems

Preparation

Baste the hem, mark the desired depth, sew and trim surplus fabric. Refer to instructions for sewing knits (Page 34).

Visible hem with Jersey stitch

Stretchy seam for all jerseys in cotton, fine wool, synthetic and blended fibres.

Needle: 80

Thread: Sewing thread

Feed-dog: 

● Stitch: A1/8

Jersey stitch



Visible hem with Triple zig-zag

Hard wearing seam for all firm woven fabrics, e.g. denim, canvas, etc.

Needle: 80

Thread: Sewing thread

Feed-dog: 

Stitch: A2/6

Triple zig-zag

Stitch width: 2 1/2-5, depending on the fabric

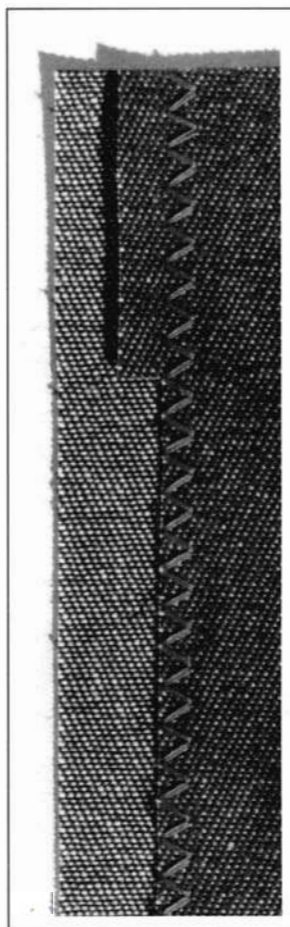
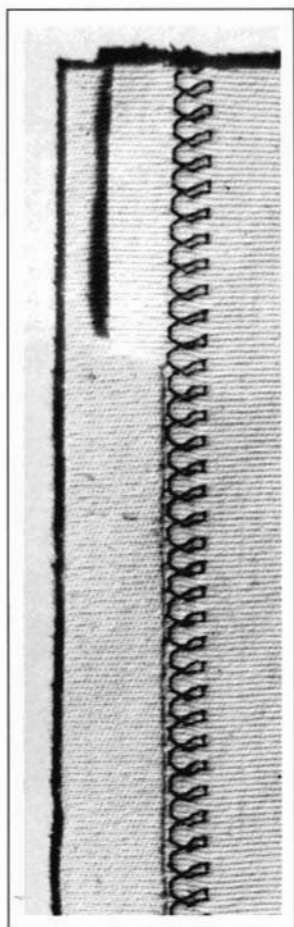

Sewing knitted fabrics

Important:

1. Use a perfect needle. Even a very slightly blunt needle will damage knit, causing it to ladder.
2. Use fine thread, particularly for fine knits. Coarse thread can also damage the knit.
3. Use darning thread for basting. It is easier to remove than the thicker and shorter fibre basting thread.
4. Press each seam as it is sewn before moving on to the next stage of sewing.

5. Sew a sample to test stitch and stretch. As the elasticity of modern fabrics varies considerably, the basic setting should be adjusted where necessary to suit the fabric.

To achieve maximum stretch:
– shorten the stitch length slightly and/or
– increase the stitch width slightly.
This puts more thread in the seam and improves its elasticity. The seam should stretch as much as the fabric.

Neckband with Honeycomb stitch

Suitable for medium to heavy-weight knits.

Needle: 80
Thread: Sewing thread
Feed-dog: 

● Stitch: A1/9

Honeycomb stitch



Press 1 cm ($\frac{3}{8}$ ") to wrong side. Sew from the right at a foot's width from the edge. Trim surplus fabric on the wrong side (if necessary).

Neckband with overlock

Suitable for all fine jerseys and knits.

Needle: 80/70
Thread: Sewing thread
Feed-dog: 

● Stitch: A1/3

Vari-Overlock



Fold band in half and press. Pin to the right side of the neck edge, matching the edges. When sewing, guide the raw edges along the pin on the foot.

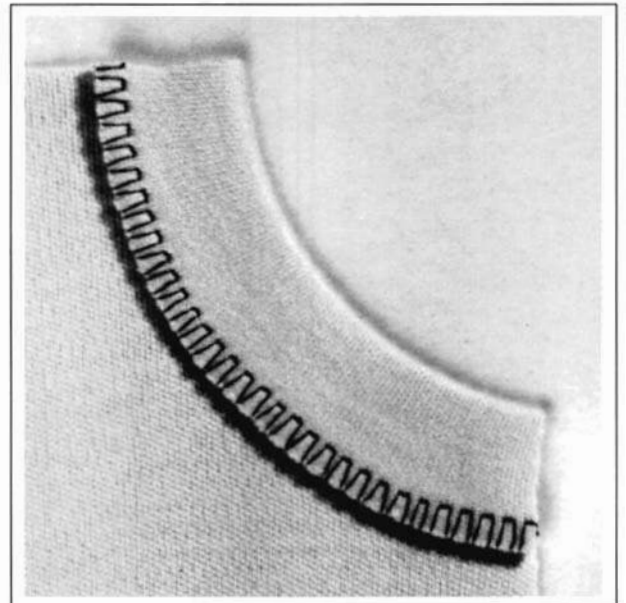
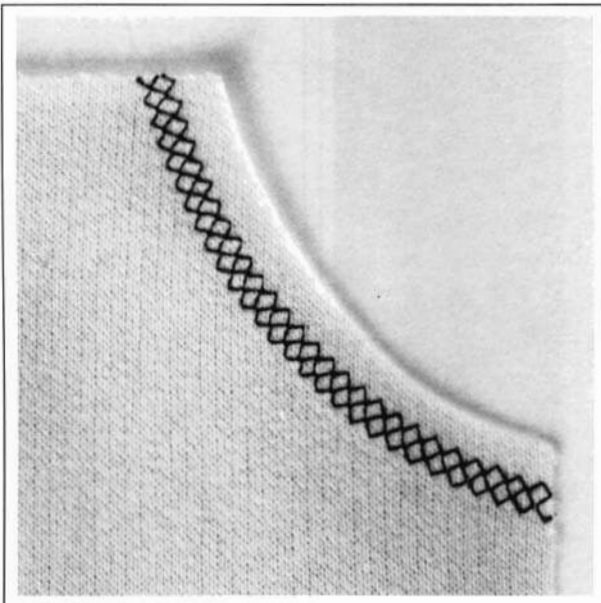

Zips / Jeans foot

Sewing in zips

Needle: 80

Thread: Sewing thread

Zip foot: 4

Feed-dog: 

● Stitch: A1/1

Straight stitch

Adjustment:
needle position left/right

Tension:

adjust to 6-7

Method:

Baste the zip into position so that the teeth are covered by the fabric. Sew in the zip, each side from bottom to top, once with needle position right and once with needle position left.

Tip:

Hold thread when starting to sew, especially on outer edges, pockets, etc.

If the fabric and/or zip make a thick, hard surface, it is worth trying a 90 or 100 needle to obtain perfect stitch formation on both sides.

Seams in thick fabrics

The Jeans foot is particularly suitable for sewing thick and hard fabrics like denim. Adjust stitch length to between 3 and 4 depending as required.

Please note that needle position must be set to «Centre» and stitch width to «0».

Important: Use a Jeans or No. 100 needle!

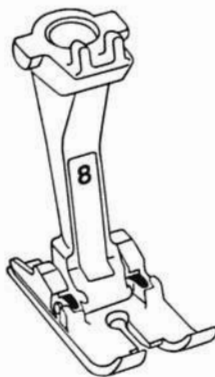
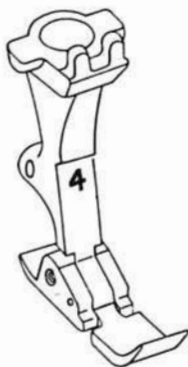
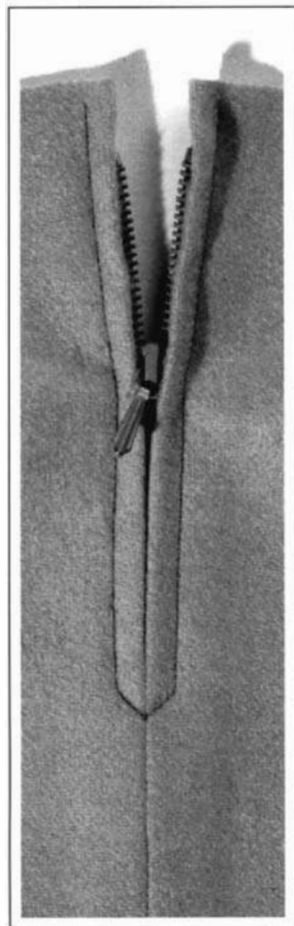

Long stitch / Basting stitch

The machine sews every second stitch. The maximum stitch length is 10 mm/ $\frac{3}{8}$ ".

Long stitch

Needle: 80

Thread: Sewing thread

Feed-dog: 

● Stitch: A1/1

Straight stitch

Stitch length: $3\frac{1}{2}$ -5

Function:

Long stitch

The Long stitch function can be combined with Triple straight stitch for top stitching.

For top stitching with buttonhole twist (Cordonnet): Use needle 100-110!

The Long stitch can be used to baste very fine fabrics.

Basting stitch

The machine sews every fourth stitch. Maximum stitch length is 20 mm/ $\frac{3}{4}$ ".

Needle: 80-90

Thread:

Sewing / darning thread

Feed-dog: 

● Stitch: A1/1

Straight stitch

Stitch length: $3\frac{1}{2}$ -5

Function:

Basting stitch

Tip: To secure the beginning and end of the seam, sew a few stitches with normal straight stitch.

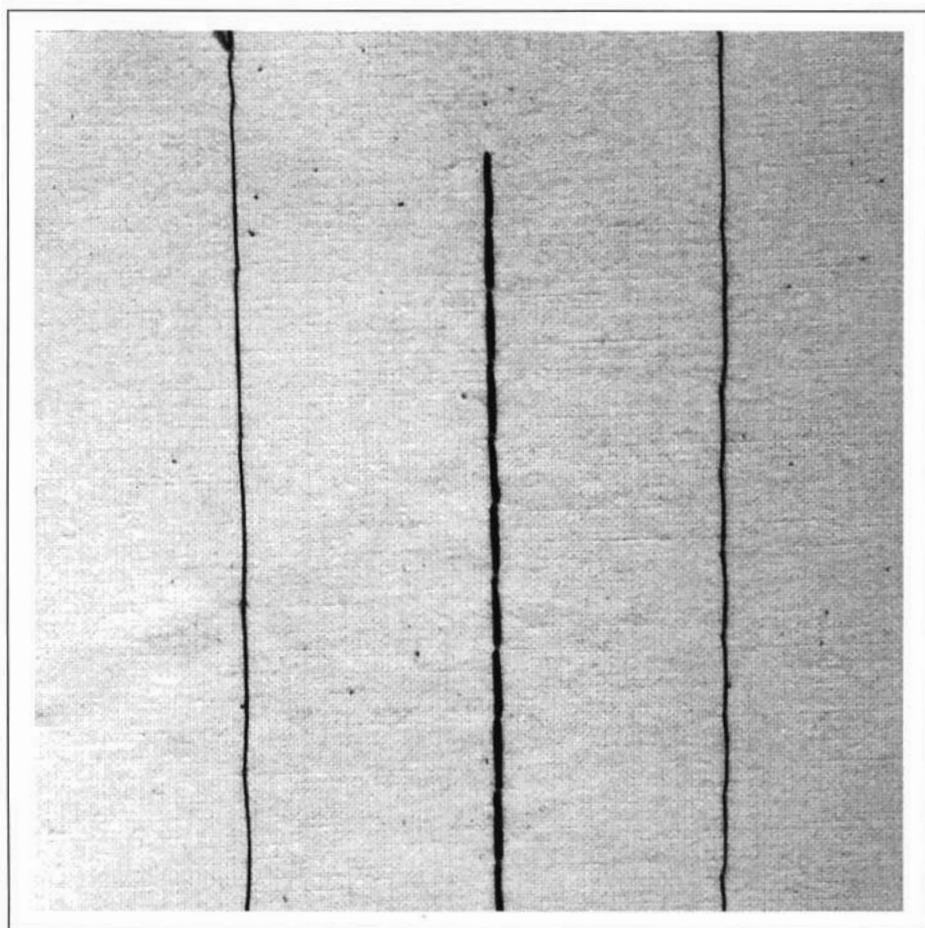

Blind hem

Needle: 80

Thread: Sewing / darning thread

Feed-dog: 

● Stitch: A1/5

Blind stitch



Preparation

Prepare hem as for hand sewn hem.

Positioning the hem

Position work under the foot as shown in fig. 1.

Sewing

The needle should just catch the edge of the fabric, as when sewing by hand. Given the variations in fabric qualities and thicknesses, it is advisable to test sew. Minor adjust-

ments to the stitch width may be necessary.

Tip:
While sewing, hold the fabric back slightly.

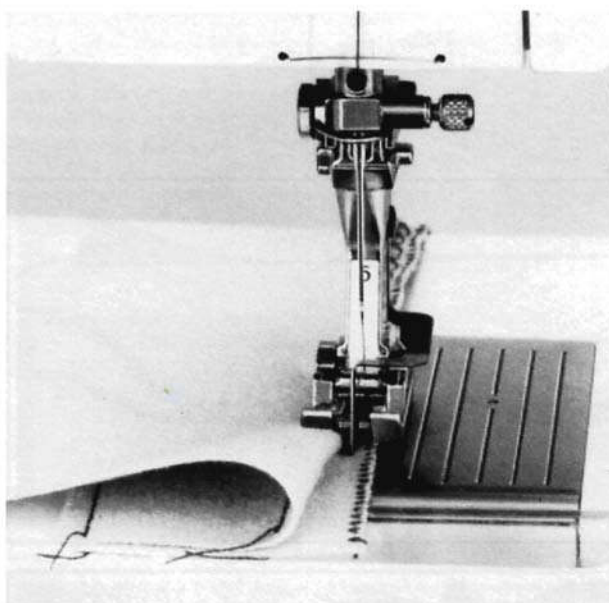

▲1

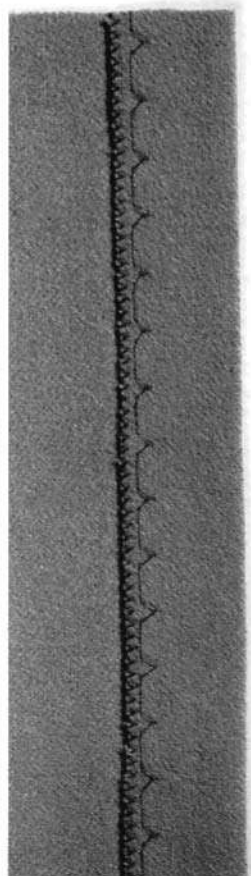

Sewing on elastic

Sewing on elastic/perle yarn with the Gathering stitch

For gathering long sections of fabric; for frills and flounces on children's and doll's clothes and for home dec and crafts.

Needle: 80

Thread: Sewing thread

Feed-dog: 

● Stitch: A2/4

Gathering stitch

Presser foot:

No. 3 Buttonhole foot
(recommended)

Cut a length of shirring elastic or perle yarn double the length of the fabric. Fold in half and slip the loop onto the centre prong on the buttonhole foot. Lower the needle into the fabric. Take both ends under the foot to the back and lower the foot.

Holding the ends firmly at the back of the foot, lift the loop off the prong and pull the elastic or yarn through to the front through the grooves on the foot, leaving short ends behind the foot and sew. If sewing elastic, stretch the elastic as you sew. The more you pull, the tighter the gather will be. Perle yarn is simply oversewn and the fabric is gathered afterwards by pulling on the yarn. At the beginning and end of each row, sew a few stitches with the feed-dog lowered.

Sewing on narrow flat elastic with the Universal stitch

For gathering long sections of fabric; for waistlines and cuffs, sportswear, children's and doll's clothes, home dec, crafts, etc.

Needle: 80

Thread: Sewing thread

Feed-dog: 

● Stitch: A2/2

Universal stitch

Stitch width: adjust to width of elastic

Cut elastic to length required. Oversew the elastic, taking care not to pierce it with the needle. Even out the gathers after sewing.

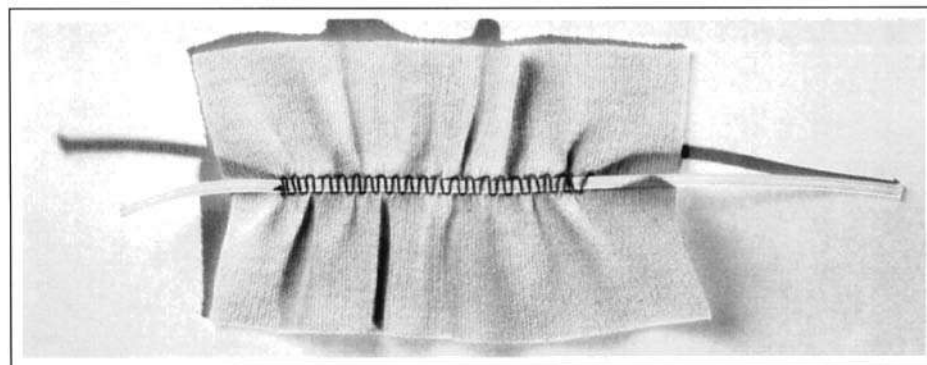
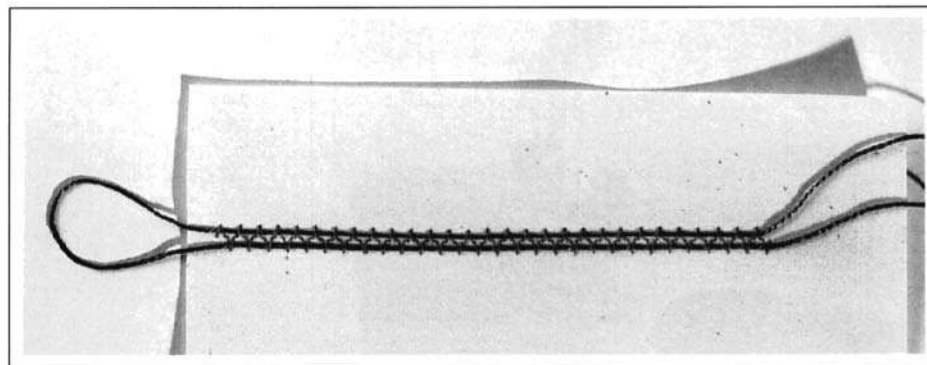

Sewing on elastic

Sewing on wide elastic with Sewn-out Zig-zag or Lycra stitch

For sportswear, lingerie,
children's clothing, etc.

Needle: 80

Thread: Sewing thread

Feed-dog: 

● Stitch: A2/1 or
A2/3

Sewn Zig-zag or
Lycra stitch

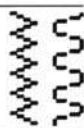

Cut elastic to length
required. Pin and sew. Trim
the surplus fabric.

Tip:
Sew a row a long straight
stitches, pull on the lower
thread and gather to the
required length. Then sew
on the elastic. This is a
simpler method as the
elastic does not have to be
stretched while sewing.

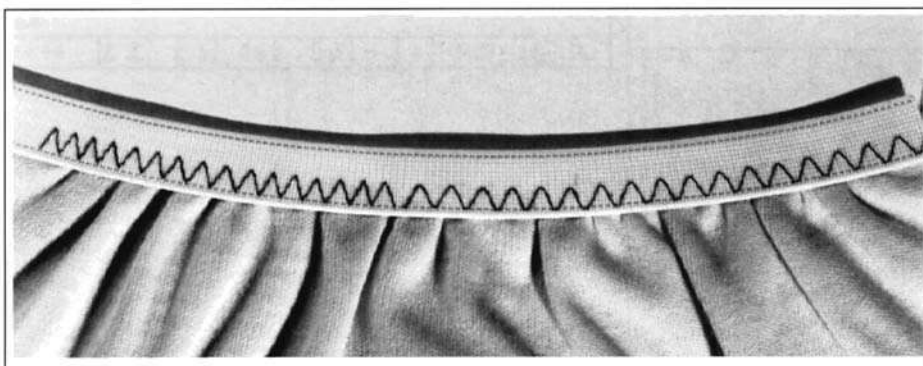

Automatic mending / Bartack programme

Automatic mending

Quick and easy mending method for tears and worn areas on practically all woven fabrics.

Simple mending

Needle: 80

Thread: Darning thread

Feed-dog: 

● Stitch: A2/9

Simple mending

Presser foot: No. 3C

Buttonhole foot with slide

Symbol: Securing button on head frame

Activate the simple mending programme. Insert needle above and to the left of the section to be mended.

Sew the first row. Press the securing button to programme the length. For rows 30 mm (1³/₈") long, the machine programmes the length automatically. The machine completes the mending programme and stops automatically.

Larger sections can be mended by starting at a different point and repeating the mending programme.

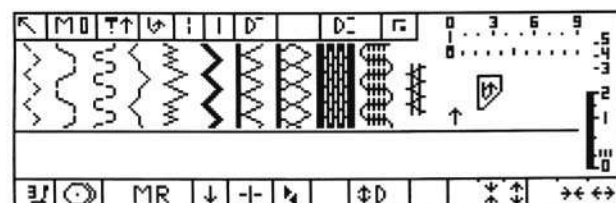

Reinforced mending

Needle: 80

Thread: Darning thread

Feed-dog: 

● Stitch: A2/10

Reinforced mending

Presser foot: No. 3C

Buttonhole foot with slide

Symbol: Securing button on head frame

Activate reinforced mending programme. Insert needle above and to the left of the section to be mended.

The machine sews a row with Running stitch. Press the securing button to programme the length. For rows 30 mm (1³/₈") long, the machine programmes the length automatically.

The machine completes the mending programme and stops automatically.

Larger sections can be mended by starting at a different point and repeating the mending programme.

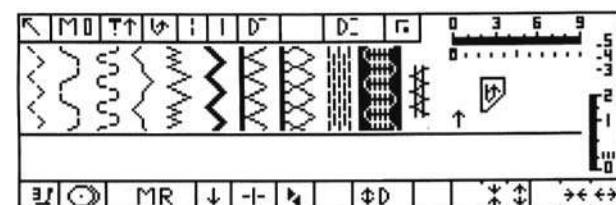

Bartack programme

Primarily for reinforcing seams subject to wear such as pocket openings on jackets, jeans and overalls and for mending or reinforcing buttonholes.

Needle: 80

Thread:

Sewing/darning thread

Feed-dog: 

● Stitch: A2/11

Bartack programme

Activate the Bartack programme. Hold the threads and start sewing slowly. The machine starts top left and completes a row. The machine stops automatically.

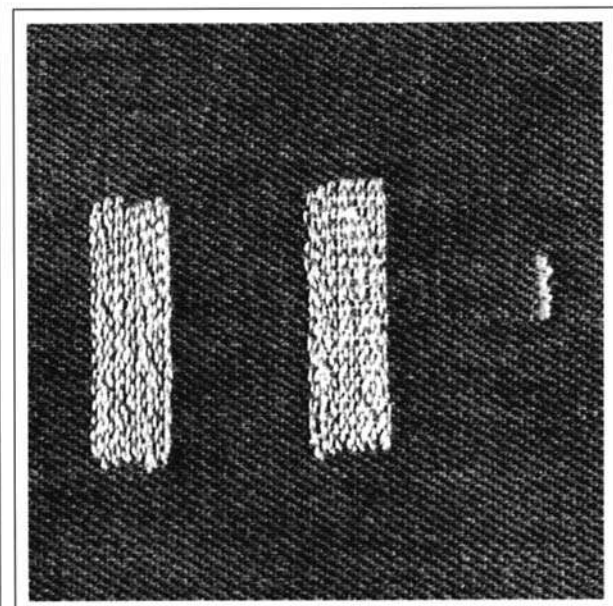
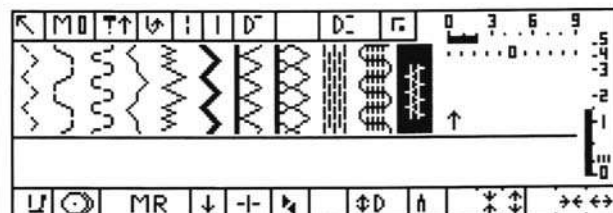

Manual darning

Basic darning principles

The feed-dog must always be lowered for darning. The work is moved to and fro by hand and not by the machine. It is important to move the work evenly and this requires a little practice.

Recommendation:
Whenever possible, use the darning ring to keep the darning area taut. Move the ring backwards and forwards smoothly; jerky movements result in torn threads. Always work from left to right, moving up and down over the hole, not from side to side. Use the sewing table and support your elbows on the work table. Position the machine slightly back from the edge of the table.

Darning

Needle: 80-70

Thread: Darning thread

Feed-dog: 

● Stitch: A1/1

Straight stitch

Stitch length: 0

Presser foot:

No. 9 Darning foot

Important

At the end of rows, change direction in curves and not points otherwise the fabric is likely to tear.



The three steps

1. Darn from top left to top right of hole. Turn by 90 degrees.

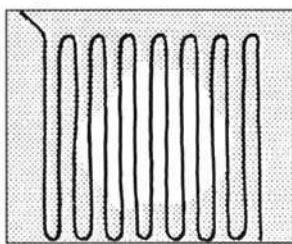

2. Work from left to right, filling in the hole but not too densely. Turn by 180 degrees.

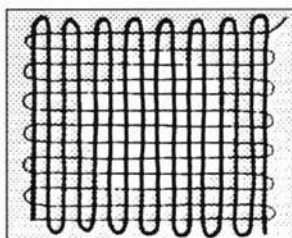

3. Fill in the darning, working in the same direction as step 2, but only over the hole and not to the edge of the darn.

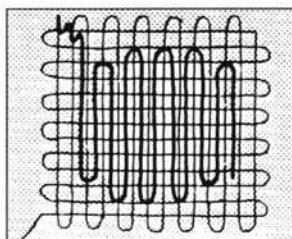

Main faults

Thread breaks frequently:
– work not moved evenly.

Stitch uneven and obtrusive:
– fabric moved too quickly in relation to the sewing speed.

Small knots on the underside:
– fabric moved too slowly in relation to the sewing speed.

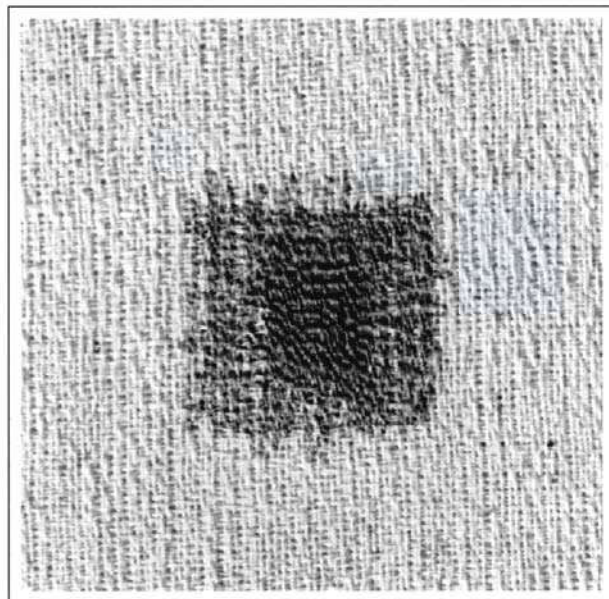
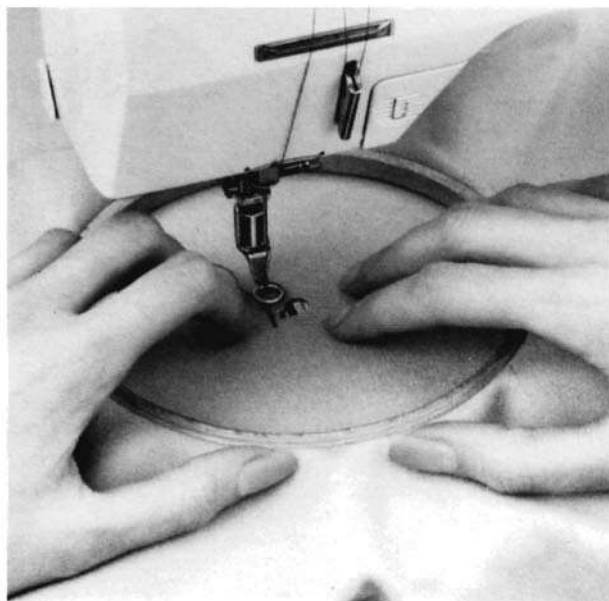

When the darning technique has been mastered, work rows of stitches in irregular lengths so that the darn blends into the fabric.

Darning with the small darning ring

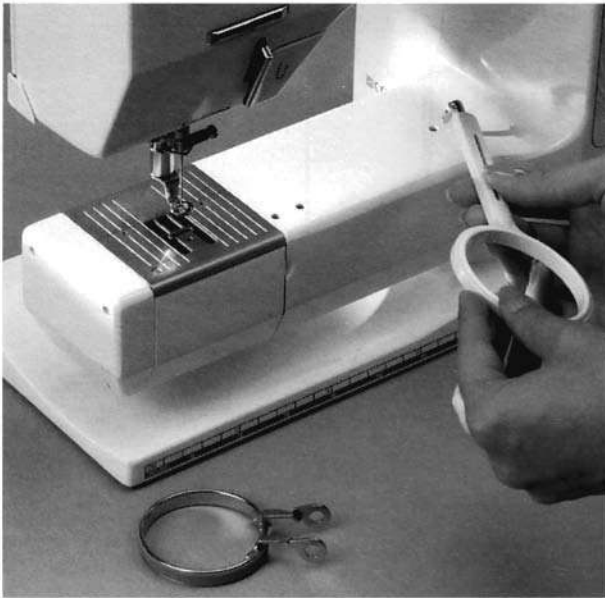

▲1



▲2

▼3

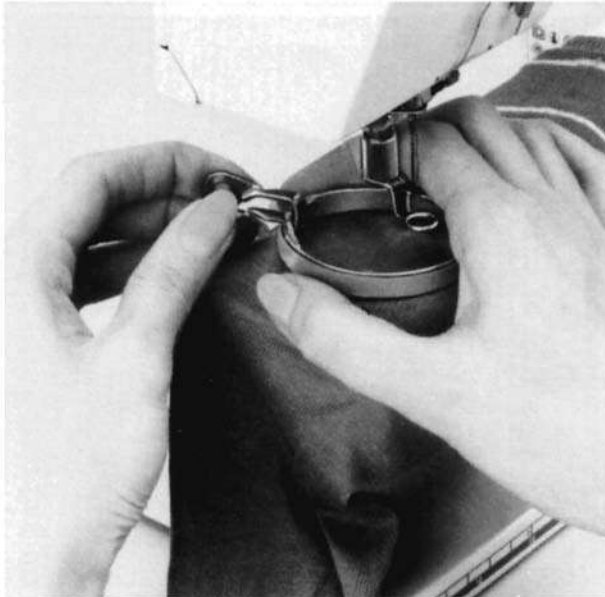

The small darning ring

The small darning ring is particularly practical for darning small torn/worn areas in fine fabrics and in fine underwear, socks and pullovers, e.g. in Helanca, interlock and jersey.

Stretching the work

Fit the darning ring without the spring clip onto the free arm (fig. 1).

Slide the garment over the free arm and the darning ring.

Push the darning ring as far as possible to the left. Place the index finger and the thumb of the right hand on the darning ring to form a circle.

With the left hand, stretch the fabric over the end of the free arm. Hold the tensioned fabric with the thumb of the right hand. Using the left hand, fit the spring clip as follows: close the spring clip, insert it under the index finger of your left hand and hold firmly. Then press the spring clip down into the ring (fig. 3).

Darning technique

Tubular items are usually stitched up and down and then side to side as it is not possible to turn the work.

Mending woven fabrics

Reinforcing edges with Running or Honeycomb stitch

Ideal for heavy duty wear such as overalls and for table linen and items made from towelling.

Needle: 80-70

Thread: Darning thread

Feed-dog: 

● Stitch: A1/4 or A1/9
Running stitch/
Honeycomb stitch



Stitch length:
Adjust as required to suit
the fabric

Tip:
Sewing in cord strengthens
the edges.

Oversew the edges with Running or Honeycomb stitch. If necessary, sew a second row slightly in from the edge.

Feed the cord into the machine and oversew.
Suitable cords: perle yarn, buttonhole yarn (cordonnet), fine crochet yarn.

Patches with Running or Honeycomb stitch

Both stitches are ideal for sewing on patches. Cut out a square or rectangular patch and sew on. (See Mending Interlock, page 45).

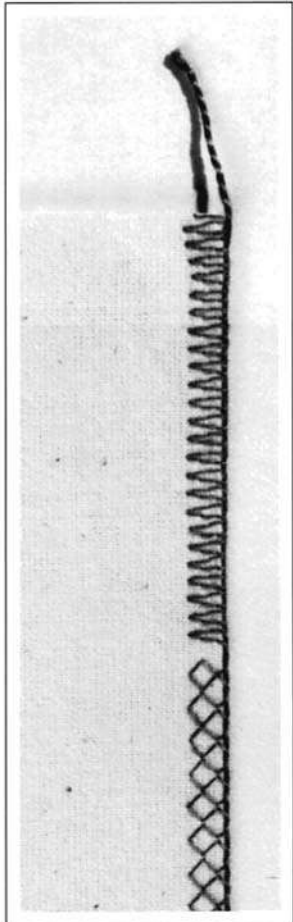

Automatic mending in 4 directions

Automatic mending in 4 directions

For sewing on patches (square or rectangular) to tubular items such as trousers and sleeves without having to turn the work.

Needle: 80-90

Thread:

Machine / darning thread

Feed-dog: 

Stitch:

B1/1-7

When the automatic mending programme is selected, the practical stitches which are suitable for various fabrics appear on the screen. The basic settings, i.e. stitch width and length, are pre-programmed for these stitches and cannot be altered.

A directional indicator appears on the right of the screen.

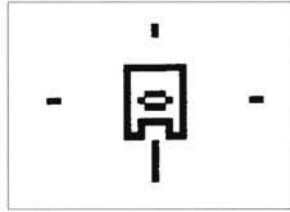

Cut out a patch slightly larger than usual and place in position. Activate your chosen stitch and sew along the first edge at a foot's width. The machine sews forwards.

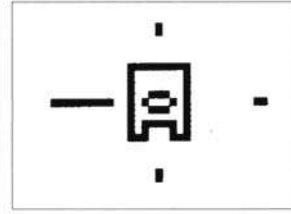

To change direction, move the cursor to the direction desired on the indicator (e.g. left) and press OK. The machine will now sew to the left.

Sew the second direction at a foot's width as well so that the foot lies evenly.

Continue sewing all sides by selecting the direction as above.

Recommendation:

Sew the patch in a clockwise direction from right to left (see drawing).

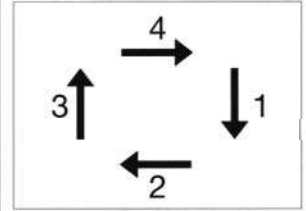

Tip:

Use Pattern End 2-9x for easier mending. After sewing is completed, trim the excess fabric close to the stitches.

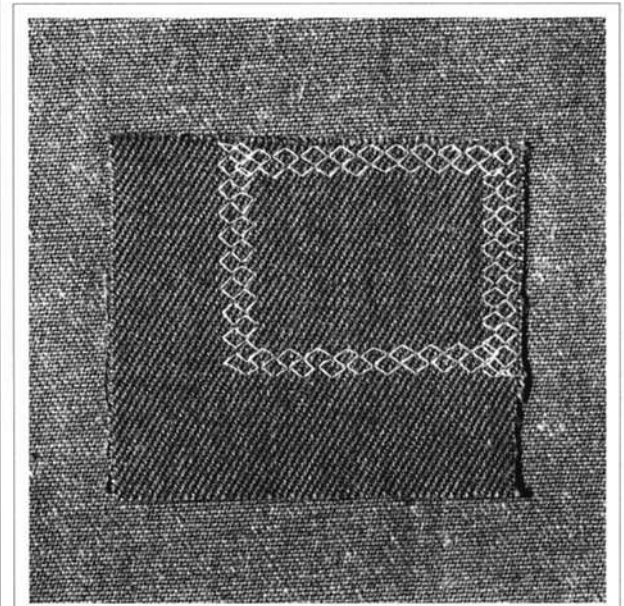

Mending interlock fabrics

Patching using Jersey stitch

Primarily for mending interlock underwear.

Needle: 80-70

Thread: Darning thread

Feed-dog: 

Stitch: A1/8

Jersey stitch



This method of mending is particularly suitable for large worn areas as the garment retains its elasticity.

Method:

To maintain stretch in all directions, round off the corners of the patch. Place the patch over the worn area and sew on with 1-2 rows of Jersey stitch. Then cut away the worn section from behind.

Edging with shirring elastic

Elastic restores distorted edges to their original shape.

Needle: 80-70

Thread: Darning thread

Feed-dog: 

● Stitch: A1/2

Zig-zag



Stitch width: approx. 5

Stitch length: 1 1/2-2

Guide two strands of elastic along the edge and sew in place with zig-zag stitch, gently pulling on the elastic as you sew.

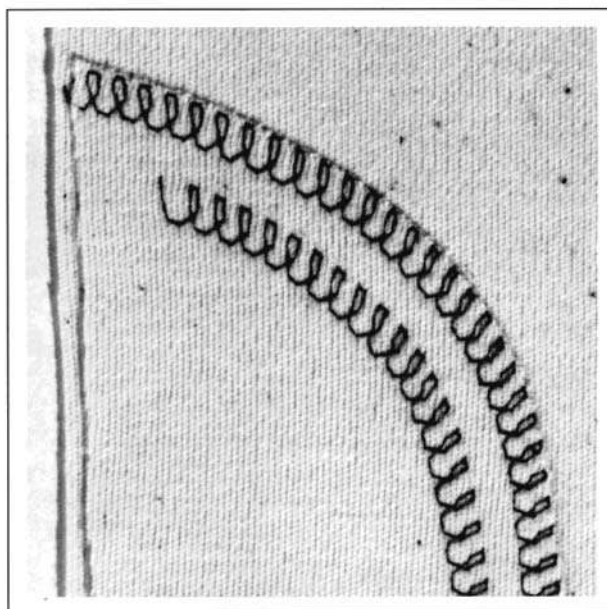
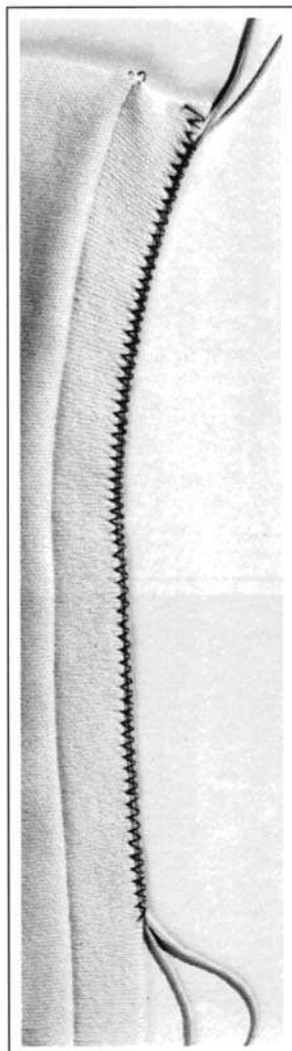
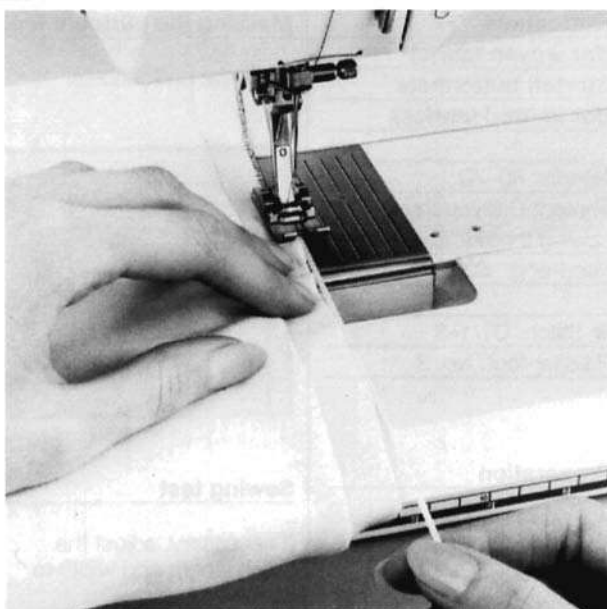

Four step buttonhole / Four step stretch buttonhole with gimp cord

Buttonhole
(for woven fabric)
Stretch buttonhole
(for knitted fabrics)

Needle: 80-70

Thread: Darning thread,
sewing thread

Feed-dog: 

● Stitch: C1/1-3

Presser foot: No. 3

Preparation

Depending on the fabric, the thread tension can be adjusted with the thread tension dial in the shaded area.

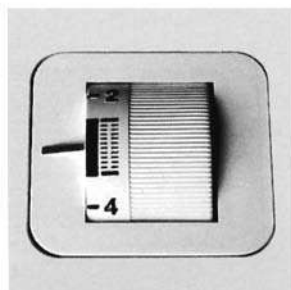

Marking the buttonholes

Mark the buttonholes.

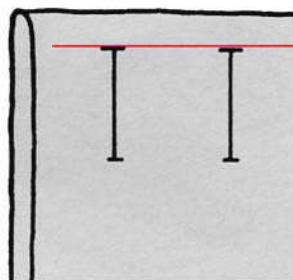

Sewing test

If necessary, adjust the stitch length and width to suit the fabric:

- bead density with the stitch length dial
- bead width with the stitch width dial

Tip:
Always test sew buttonholes on the fabric (and interfacing) to be sewn!

Sewing buttonholes

Select the buttonhole programme. The first buttonhole is activated, machine is ready to sew the first (left) bead forwards. Insert the needle exactly at the beginning of the buttonhole, lower the presser foot.

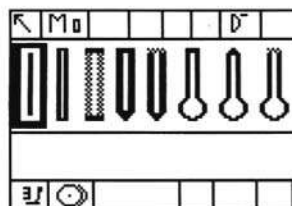

Sew the first bead forwards to the desired length. Press the securing button on the head frame and the machine is now set to sew the next step (symbol on screen).



The machine sews reverse straight stitch back to the starting point. Press the securing button to set the next step.

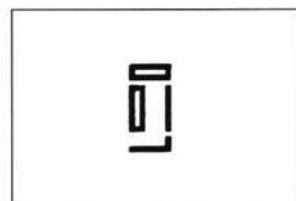

The machine sews the first bartack and the second bead. Press the securing button to set the next step.



The machine sews the second bartack and securing stitches. The machine stops automatically at buttonhole begin.

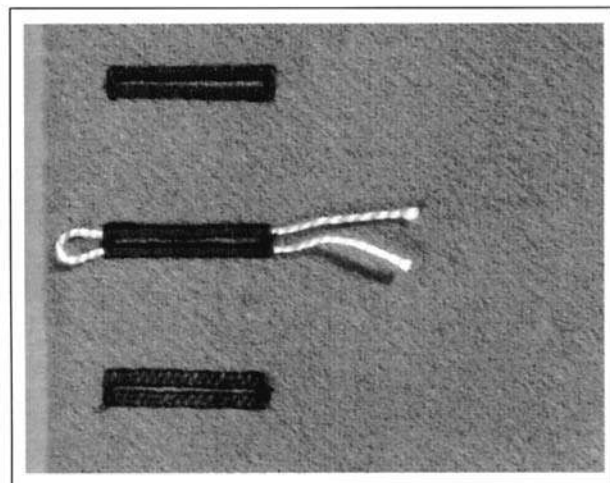

Four step buttonhole / Four step stretch buttonhole with gimp cord

Buttonholes with gimp cord

Gimp cord strengthens buttonholes. Suitable cords are perle yarn No. 8, buttonhole thread, fine crochet cord. The loop should lie at the end of the buttonhole most subject to wear, so place the fabric under the foot so that the loop comes at the appropriate end.

Positioning the cord

It is easier to position the cord when the needle is in the fabric. Bring the needle to centre of the foot and lower it into the fabric at the exact start of the buttonhole. Do not lower the foot yet.

Hook the gimp cord over the centre prong of the foot (fig. 1) and take both ends under the foot to the back (fig. 2). Lower the foot and check that the cord slides easily. Sew the buttonhole. Do not hold the cord but let it slide freely. When sewing is complete, pull the loop into the buttonhole.

Securing

Take the ends of the cord through to the wrong side with a sewing needle (fig. 3) and knot or sew in securely.

Cutting buttonholes open

Cut from the ends towards the centre (fig. 4) or use a special buttonhole cutter with wood block.

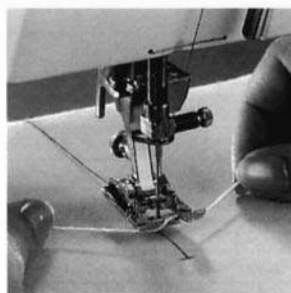

▲1

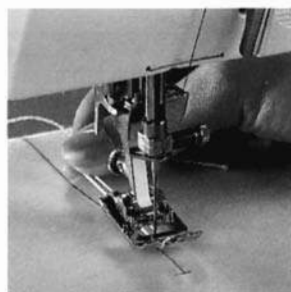

▲2

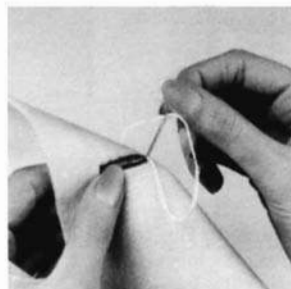

▲3



▲4

Four step round buttonhole / Four step keyhole buttonhole

Round buttonhole / Keyhole buttonhole

Needle: 80

Thread: Sewing thread

Feed-dog: 

● Stitch: C1/4-8

Presser foot: No. 3

Preparation

Depending on the fabric, the thread tension can be adjusted with the thread tension dial in the shaded area.

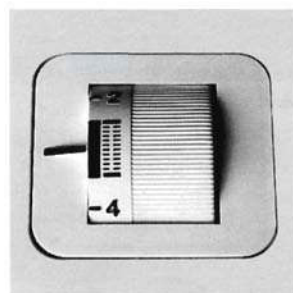

Marking the buttonholes

Mark the bead length. The length of the curve or eye of the buttonhole must be included in the calculation.

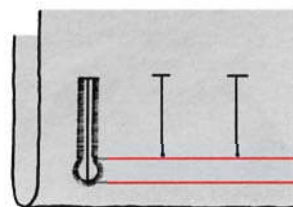

Sewing test

If necessary, adjust the stitch length and width to suit the fabric:
– bead density with the stitch length dial
– bead width (buttonhole width) with the stitch width dial

Tip:
Always test sew buttonholes on fabric (and interfacing) to be used!

Sewing buttonholes

Activate the desired buttonhole. Insert the needle at the beginning of the buttonhole and lower the presser foot.

The machine sews straight stitch to the bead length required. Press the securing button to set the machine to the next step.

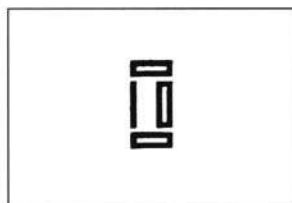

The machine sews the curve or the eye. The machine is ready for the next step.

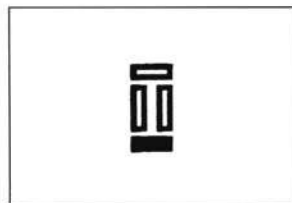

The machine sews the first bead in reverse. Press the securing button to set the next step.



The machine sews the straight stitch forwards up to curve or eye. Press the securing button to set the next step.



The machine sews the second bead in reverse. Press the securing button to set the next step.



The machine sews the bartack and securing stitches. The machine stops automatically at buttonhole begin.

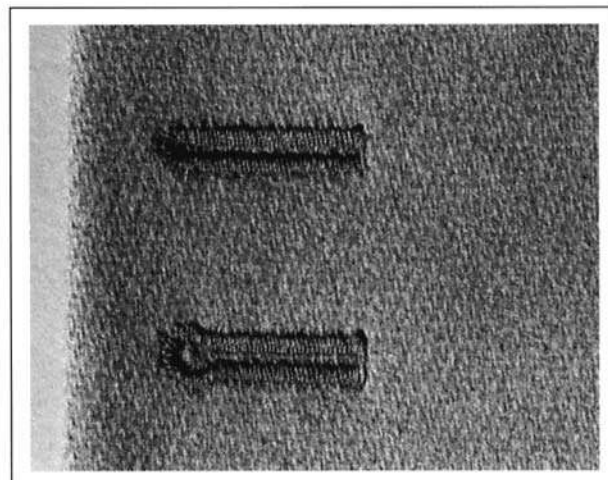
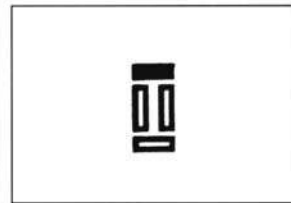

Cutting the buttonholes

See page 47.

Fully automatic standard buttonhole

(woven fabrics)

Fully automatic stretch buttonhole

(knitted fabrics)

Fully automatic round buttonhole

(firm fabrics)

Fully automatic keyhole buttonhole (firm fabrics)

Needle: 80–70

Thread:

Darning/sewing thread

Feed-dog: 

Stitch: C1/1–8

Presser foot:

No. 3C (with slide)

Preparation

Depending on the fabric, the thread tension can be adjusted with the thread tension dial in the shaded area.

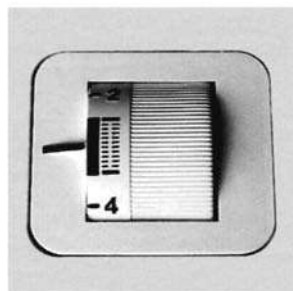

Marking buttonholes

Standard and stretch buttonholes:
Mark only the first buttonhole. After sewing the first buttonhole, the length is automatically programmed. Mark the starting point of the remaining buttonholes.

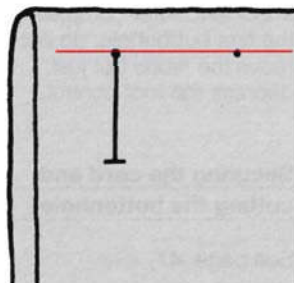

Round and keyhole buttonholes:

Mark the bead length. The length of the curve or eye should be included in the calculation.
Mark only the first buttonhole. After sewing the first buttonhole, the length is automatically programmed. The curve or eye should be at the end of the buttonhole most subject to wear.

Sewing test

If necessary, adjust the stitch length and width to suit the fabric:
– bead density with the stitch length dial
– bead width (buttonhole width) with the stitch width dial

Tip:

Always test sew buttonholes on the fabric (and interlining) to be used!

Sewing buttonholes

Activate desired buttonhole.
Machine is ready to sew the first bead forwards. Insert needle at the beginning of the buttonhole, lower the foot.
Sew the first bead forwards to the desired length. Press the securing button to programme the length.



The bracket over the buttonhole symbol shows that the length is memorised. The machine completes the buttonhole automatically, sews the securing stitches and stops at the starting point.

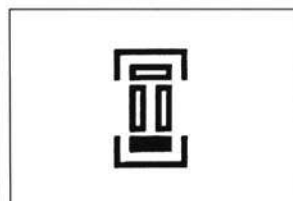

All further buttonholes can be sewn automatically. Just insert the needle into the starting point of the buttonhole and press the foot control.

Important

If the machine malfunctions, activate the function «Pattern Begin» and the machine is automatically set at buttonhole begin.

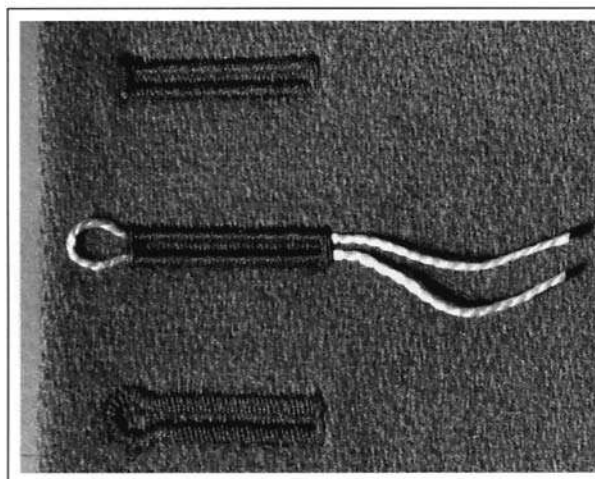

Fully automatic buttonholes with gimp cord

Gimp cord strengthens buttonholes.

Suitable cords are perle yarn No. 8, buttonhole thread, fine crochet cord. The loop should lie at the end of the buttonhole most subject to wear, so place the fabric under the foot so that the loop comes at the appropriate end.

Positioning the cord

It is easier to position the cord when the needle is already in the fabric. Insert the needle exactly at the start of the buttonhole. Do not lower the presser foot yet.

Guide the cord from the right under the foot and hook it over the prong at the back (fig. 1).

From the left, bring the cord under the foot and insert both ends into the retaining slots (fig. 2).

Fully automatic keyhole buttonhole, double sewn (reinforced)

For thicker fabrics and increased durability, it is advisable to reinforce the buttonhole by sewing it twice. (Exception: Keyhole buttonhole with pointed bartack)

Important: After completing the first buttonhole, do not move the fabric but just depress the foot control.

Securing the cord and cutting the buttonhole

See page 47.

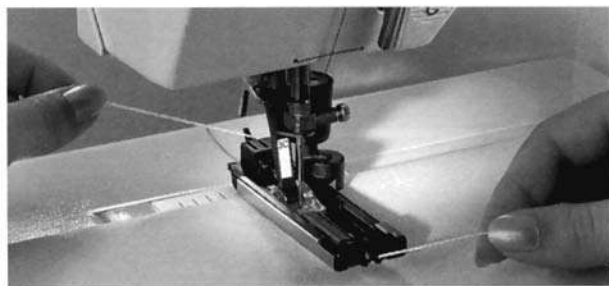

▲1

▼2

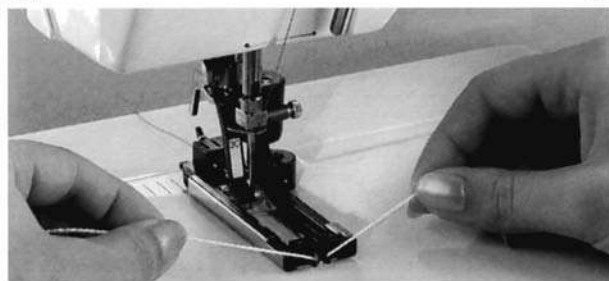

Eyelet programme / button sewing-on programme

Eyelets with narrow zig-zag, eyelets with straight stitch

Eyelets can be used in a variety of ways. They are not only suitable for cords and ribbons but they can also be used to decorative effect on children's clothing, leisure wear and crafts.

Needle: 80

Thread:

Darning/sewing thread

Feed-dog: 

● Stitch: C1/9 and 10

Eyelets

Preparation

Depending on the fabric, the thread tension can be adjusted with the thread tension dial in the shaded area.

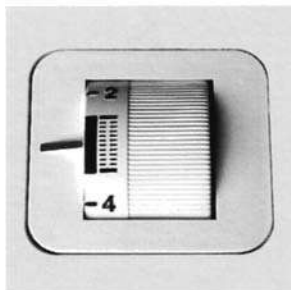

Marking eyelets

Mark the centre point of the eyelet.
Insert the needle approx. 3–5 mm (zig-zag 3 mm, straight stitch 5 mm) above the centre point.

Sewing eyelets

Activate the eyelet programme C1/9.
The eyelet will be sewn with zig-zag.
The machine stops automatically when the eyelet is complete.

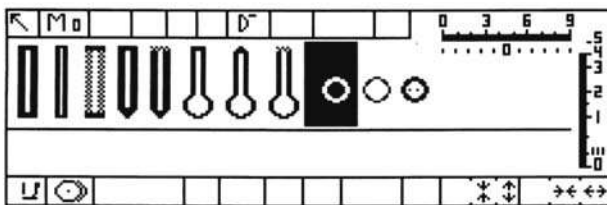

Activate the eyelet programme C1/10.
The eyelet will be sewn with straight stitch.
The machine stops automatically when the eyelet is complete.

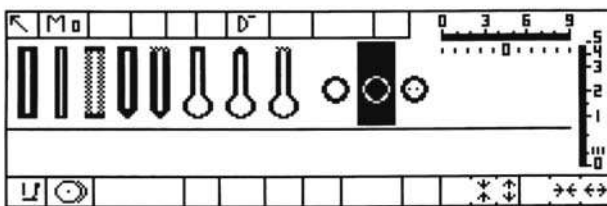

Cutting eyelets

Stamp out the centre of the eyelet with an awl or hole puncher.

Button sewing-on programme

Buttons with 2 or 4 holes can be sewn on by machine.

When using Button sewing-on foot No. 18, the length of «neck» (distance between button and fabric) can be adjusted as desired.

Needle: 80

Thread:

Sewing/darning thread

Feed-dog: 

● Stitch: C1/11

Stitch width: according to distance between holes

Presser foot: No. 18

Sewing on buttons

Activate the button sewing-on programme.

Hold the threads when starting to sew. The machine stops automatically at the end of the programme. The threads are secured and can be cut off.

Tip: Cut the upper thread close to the button. Pull both lower threads through to the wrong side and cut.

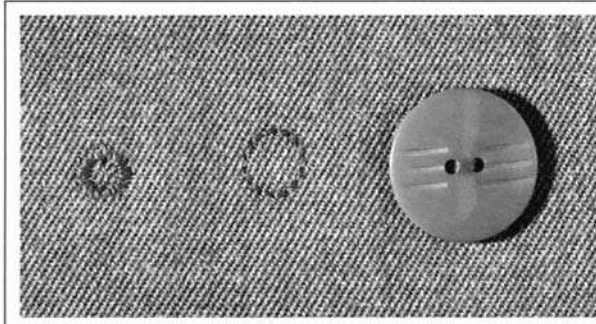
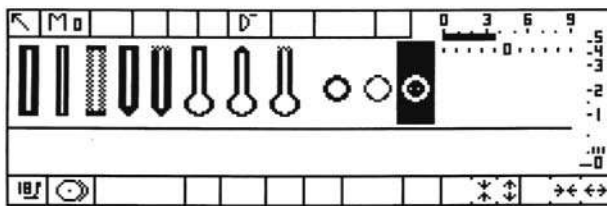

For buttons with 4 holes, sew the lower holes first and then the upper holes.

Decorative sewing

Cross Stitches

Cross stitches are an attractive addition to the usual embroidery stitches and provide scope to use your own imagination and creativity.

Needle: 80

Thread: Sewing thread, embroidery and darning threads

Feed-dog: 

● Stitch: S1/1-8

Cross stitches

Cross stitches 1-7

Sew in the same way as all other stitches.

Large cross stitch S1/8

1. Sew one line of the cross. The machine stops automatically in the centre of the line.

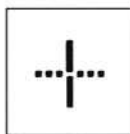

The arrow appears above the stitch symbol.

Turn work by 90 degrees.

2. Sew the second line.

The machine stops automatically at the end of the line and switches automatically to stitch begin.

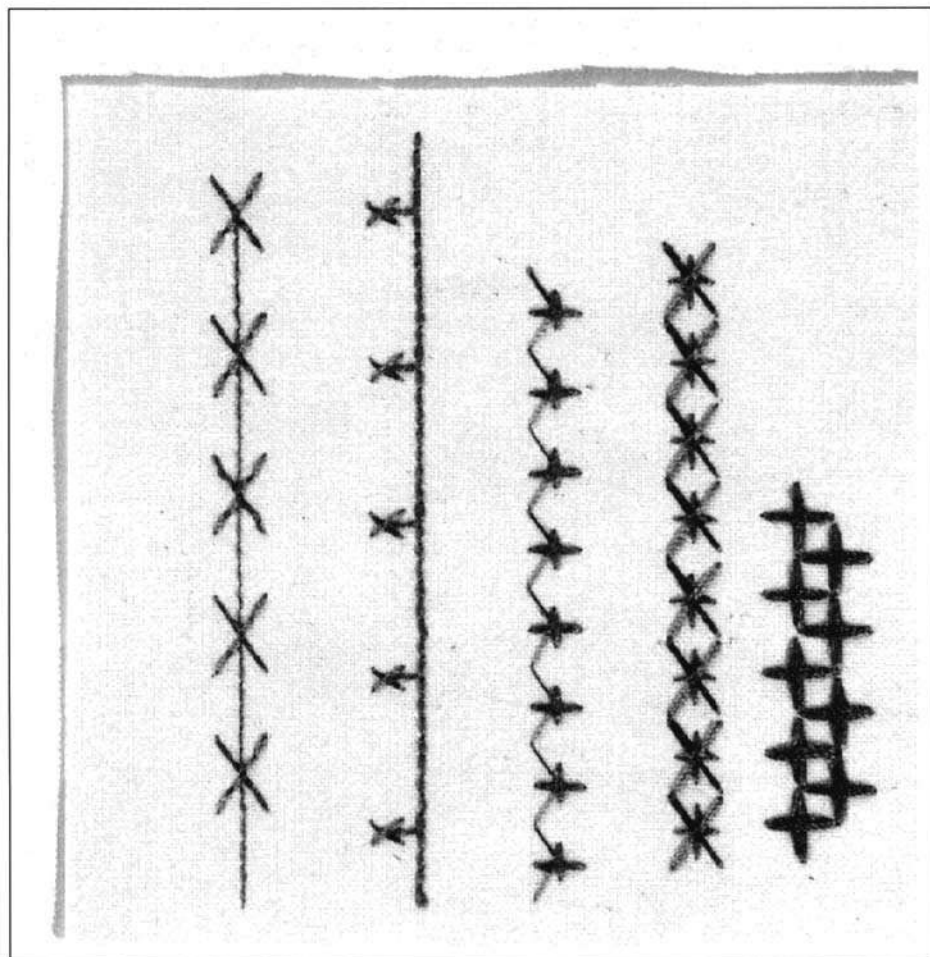







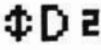

Embroidery stitches, combining with functions

Combining basic settings and functions

Unusual and attractive effects can be obtained by combining basic settings with functions.

The following functions can be combined with basic settings:

-  Mirror image right – left
-  Mirror image vertical
-  Pattern Extension
-  1/2 Pattern
-  Balance
-  Long stitch
-  Double needle limitation
-  Reverse sewing

Examples

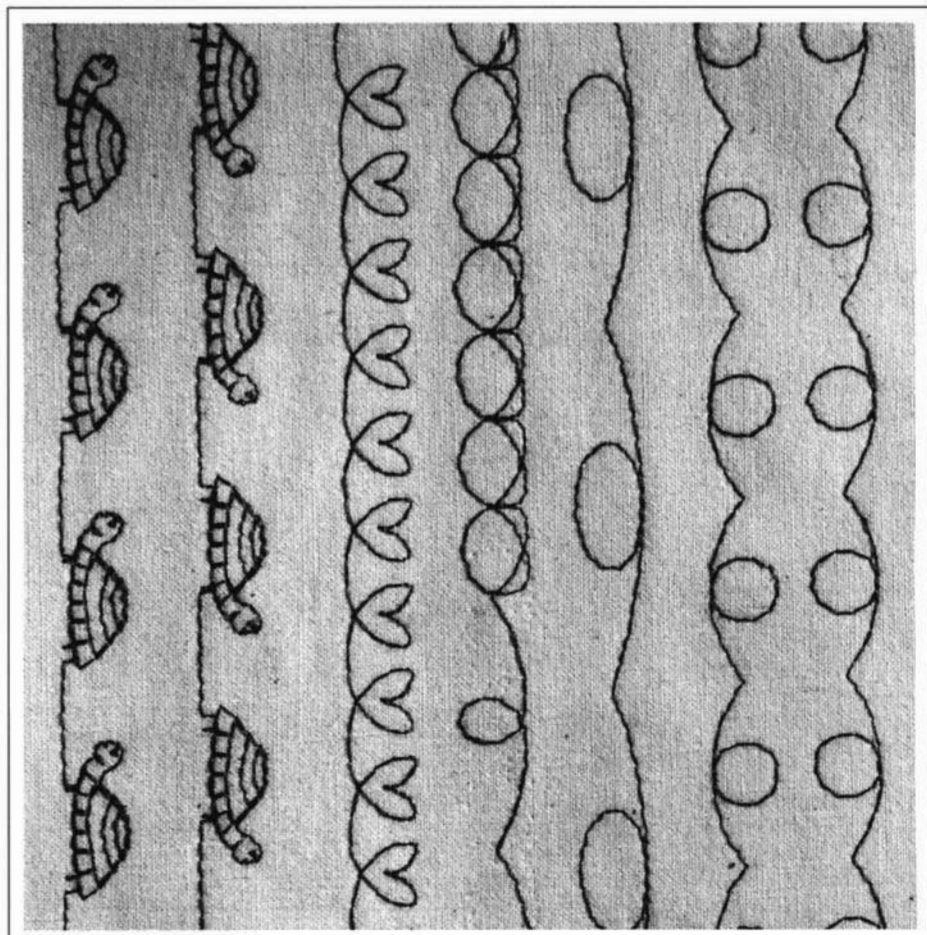
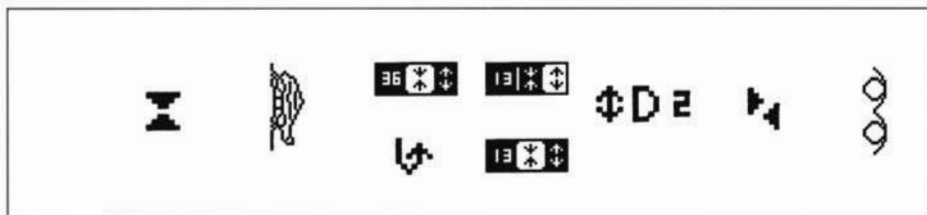

Preparation

Depending on the fabric, the thread tension can be adjusted with the thread tension dial in the shaded area.

Balance

Different effects (stitch variations) can be obtained by lengthening or shortening the stitch with the balance (Balance page 64).

Method

- Activate the desired stitch.
- Activate the desired function.

A number of functions can be combined simultaneously with a basic setting. Before activating a new variation or combination, double-click CLR to erase the functions. Erase special functions individually.

Programming allows stitches, letters and numbers to be combined, saved and edited.

Memory

There are 9 memories each containing 70 spaces. The 70 spaces in each individual memory can be subdivided.

Note: Before programming it is necessary to attach the presser foot which will eventually be used for sewing.

The saved contents of any memory selected are displayed in the programming screen. The contents can be rolled over the screen with the cursor.

Editing is possible at any time.

The memory contents remain saved and can be recalled at any time, as long as the programme was saved. Saved programmes are not affected by power cuts or if the machine is not used for some time.

When sewing a saved programme, the contents roll over the screen. The cursor marks the pattern being sewn.

Procedure

Open Memory

- + = cross cursor
- = programme cursor



Select a menu



Move cursor to MR (memory). Press OK.

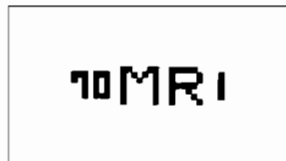

Two figures appear in the Memory screen:
 - to the left of MR = number of free spaces in the memory
 - to the right of MR = memory number (e.g. 1). Press OK to activate the next memory (e.g. 2, 3, up to 9).

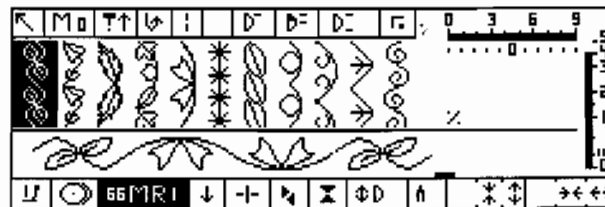

When viewing a memory, the contents and programme cursor are displayed.

After opening Memory, you can return to the one of the main menus and select the menus of your choice. The programming screen remains visible.

Programming

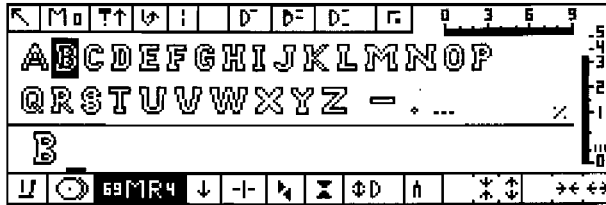

Move the cross cursor to the desired stitch and press OK. The stitch immediately appears in the programming screen. The programme cursor (-) moves to the right.

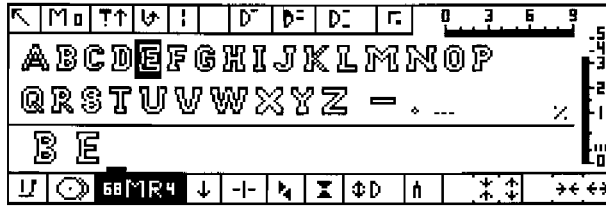

Move the cross cursor to the next desired stitch and confirm with OK. This pattern is now saved.

Continue as described above.

Programming with various functions

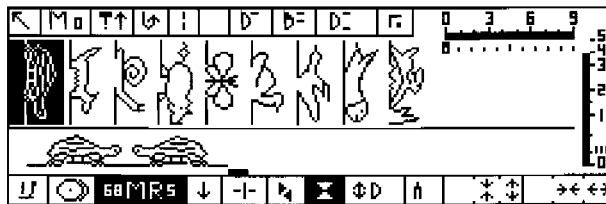

Stitches which have been combined with functions (both Mirror Image functions, Long stitch and Pattern Extension) can also be programmed and saved.

Move the cross cursor to the desired function(s) and activate with OK. Adjust stitch lengths and widths and needle position. Then move the cursor to the stitch of your choice and

press OK. The stitch will immediately appear in the programming screen. Mirror Image stitches are visible but the other adjustments are not visible on the screen.

Editing

The programme cursor (-) is always to the right of the last programmed stitch.

The last programmed stitch can be erased by simply pressing CLR.

The programme cursor must be activated for editing so that it can be moved to the left or right to alter a particular stitch. Any programmed stitch can be altered.

All changes, such as erasing or inserting, are done to the left of the programme cursor.

Erasing the last selected stitch

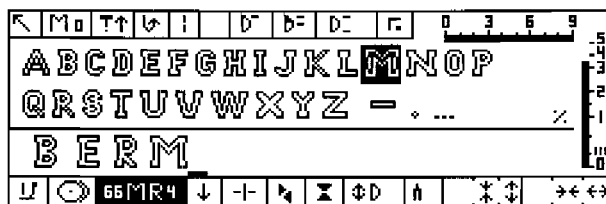

The programme cursor is always to the right of the last selected stitch. All alterations take place to the left of the cursor. Press CLR to erase the last selected stitch. The cross cursor must not be on an activated function.

Activating the programme cursor



Move the cross cursor to the programme cursor and press OK. The cross cursor disappears. Move the programme cursor to the left or right with the command ball.

To reinstate the cross cursor, press OK.

Memory

Erasing a stitch

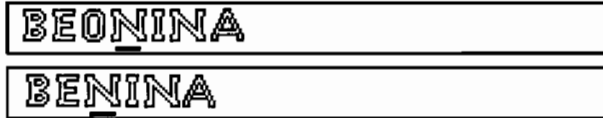

Activate the programme cursor in the programming screen.

Move the cursor to the **right** of the stitch to be erased and press CLR.

The stitch to the **left** of the cursor will be erased.

Inserting a stitch

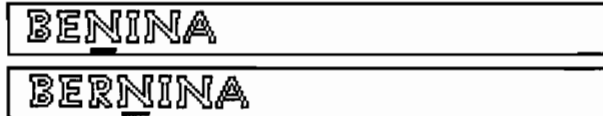

Activate the programme cursor.

Move the cursor to the right of the stitch to be inserted. Press OK to reinstate the cross cursor.

Select the stitch to be inserted and press OK. The stitch appears on the screen.

Memory subdivision

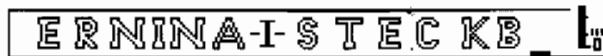

It is possible to subdivide memories (1–9) into smaller sections which can be programmed and sewn individually.

Select the Memory subdivision function and press OK. Memory subdivision is now activated.

To subdivide an existing saved programme, follow the instructions for «Inserting a stitch into a programme», using the Memory subdivision instead of a stitch.

To sew a particular section (subdivided programme), move the programme cursor to any position in the programme and activate «Pattern beginn». The cursor is now under the first stitch and the contents will be sewn. Activate «Pattern end» as desired.

To sew a further subdivided memory, repeat the above procedure.

To save a programme

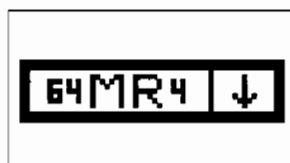

Move the cross cursor to the function Save/Leave Memory and press OK. The programme is now stored, the programming screen clear and Memory switched off.

All practical and decorative stitches can be programmed and edited in the same way.

Erasing a complete memory



The contents of a memory, e.g. memory 3, can be erased in one operation. Move the cross cursor to MR. Double-click CLR and the contents are erased.

If the contents were erased and no further stitches are to be saved, still leave memory by pressing the «Save/Leave Memory»  function.

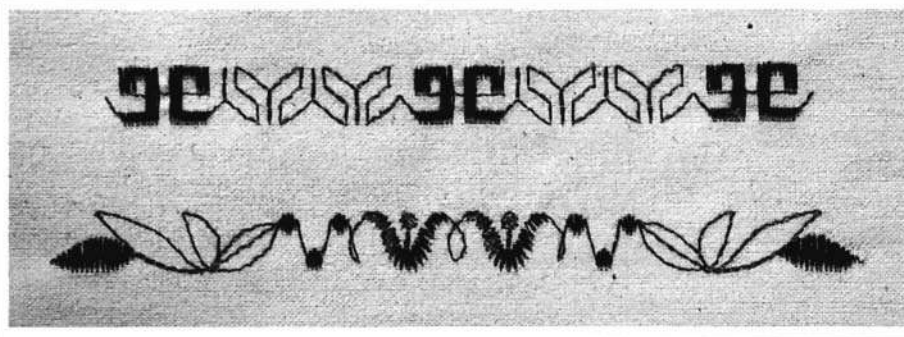

Straight and zig-zag stitches can be sewn in 16 directions.

This feature is particularly suitable for decorative work but also for practical work such as sewing on patches to tubular items (sleeves, trousers, etc.).

Needle: 80–110

Thread: Sewing, embroidery, decorative threads

Feed-dog: 

● Stitch: A1/1 or A1/2
Straight stitch or zig-zag

The straight stitch length for 16 directional sewing is generally 3 mm.

The zig-zag stitch width can be infinitely varied from 0-9 mm. The stitch length (basic setting) is preprogrammed to satin stitch. It can be shortened or lengthened up to 1.

Sewing in 16 directions

Select straight stitch or zig-zag. A compass (direction indicator) appears on the screen, at the centre of which is a presser foot.

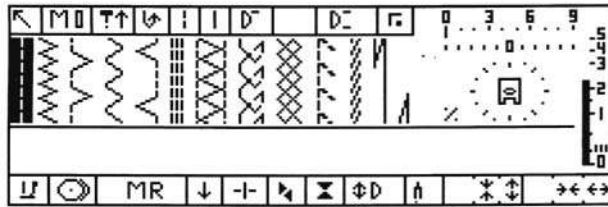

Move the cursor to the compass direction in which you want to sew and press OK.

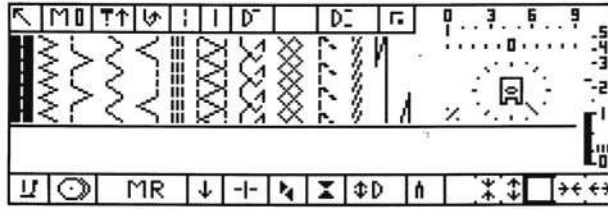

A line displays the chosen direction.

Changing direction

After sewing the length desired, select a new direction on the compass, press OK and continue sewing. Always change direction with the needle in the fabric.

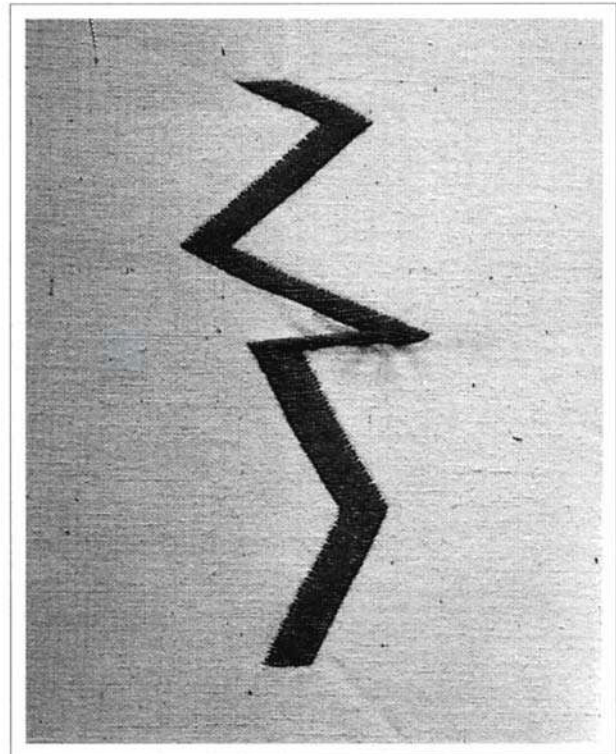
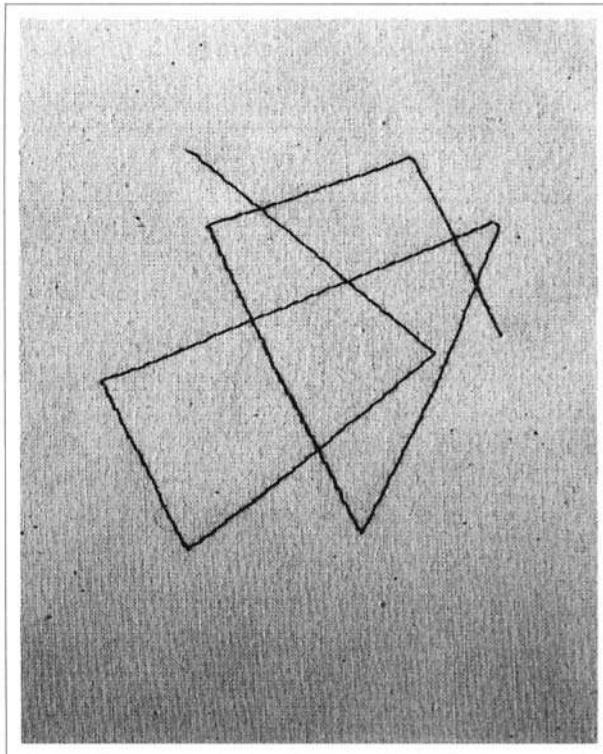

Directional sewing can be saved in the memory and opens up a whole new area for decorative sewing.

Delightful effects can be obtained by combining individual stitches, monograms and flowers with long, connecting threads which can be positioned at will and cut away afterwards.

Further decorative applications are wide connecting lines (zig-zag) or creating your own personal borders.

Compass mode in Memory

Go into Memory. The sewing direction is displayed in Memory with a presser foot and arrow. Note: The foot is displayed horizontally but the arrow indicates the actual sewing direction. Remember that the directions displayed in Memory are sewn from left to right.

A narrow arrow indicates straight stitch and a thick arrow indicates zig-zag.

One arrow equals a length of 9 mm (all stitches). If a longer length is to be sewn, the appropriate number of arrows must be inserted. The number of arrows required is given on the templates (see «Templates»).

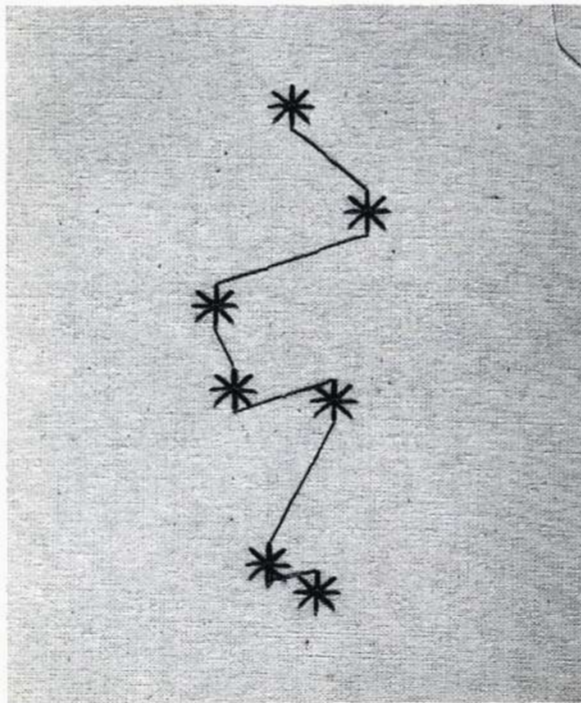
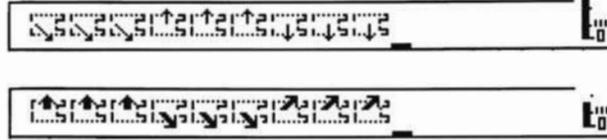

Straight stitch and Straight stitch with «Long stitch» as connecting thread**Zig-zag as connecting thread**

Connecting lines from stitch to stitch can be sewn in Memory in a variety of ways.

1. Go into memory. Select a stitch, return the cursor to straight stitch and select a direction (= arrow in Memory). The connecting line consists of 3 straight stitches which are all 3 mm long (= 9 mm).
2. Select a stitch, return to straight stitch and select a direction (= arrow in Memory) and the Long stitch function. The connecting line now consists of one 9 mm long stitch. These long stitches are mainly used as connecting lines between two programmed stitches or patterns (e.g. monograms) and can be cut away afterwards.
3. If zig-zag is programmed between 2 stitches/patterns, the length (= arrow in Memory) is also 9 mm long.

Template with compass (direction indicator) and pattern repeat indicator

The compass and pattern repeat indicator are printed on the template in order to define the desired direction and/or distances (see back inside cover).

Defining distance and direction

Templates are used to determine the placement and the beginning and end points of designs on fabric. Lay the template with the centre of the foot on the end point of the first pattern (same sewing direction!). Enter the next direction on the template (to the beginning of the next pattern) in the Memory. The number of pattern repeats (distance) is also given on the template and can be entered in the Memory by pressing OK once for each repeat. Programme the next stitch/pattern in the Memory. Continue in this manner.

Tip:
Use «Pattern End» function when sewing.

Leave Compass mode

Press CLR to switch off the compass (direction) mode.

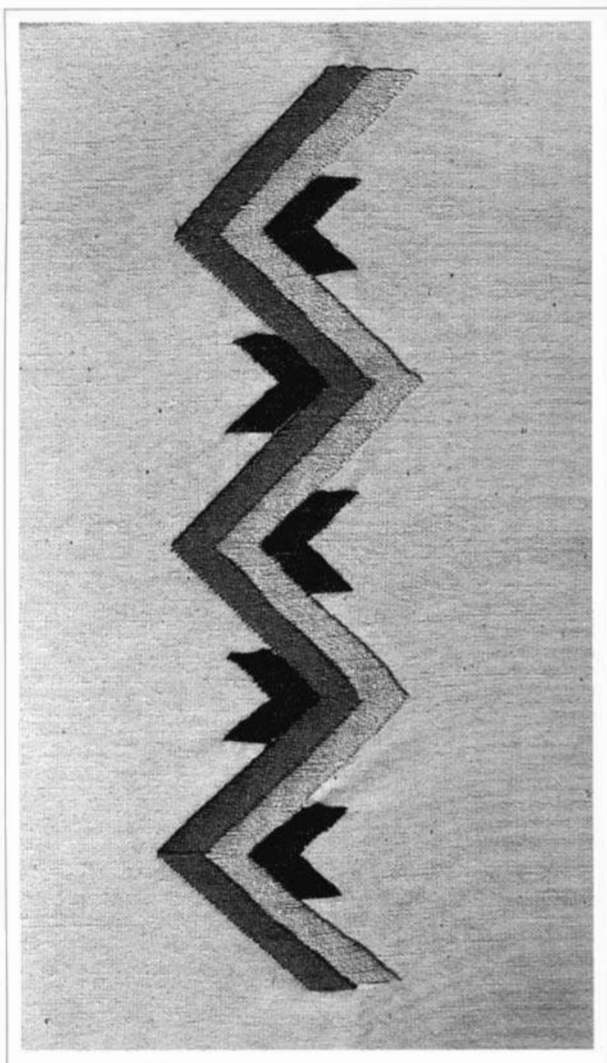

Sideways motion patterns

The feed-dog moves in a horizontal as well as a vertical direction when sewing sideways motion patterns.

Sideways motion is particularly suitable for large, decorative and flat embroidery.

Sideways motion menus are displayed on the screen with a symbol.

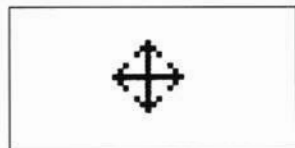

Needle: 80–90

Thread:
Sewing / decorative threads

Feed-dog:

Stitch:
Sideways motion patterns
Menus G2 / H / I / Q

Preparation

Depending on the fabric, the thread tension can be adjusted with the thread tension dial in the shaded area.

Sewing sideways motion patterns

Sideways motion patterns are preprogrammed in one size only. Stitch length, width and needle positions are predefined. The Pattern Extension function cannot be activated for these patterns.

Patterns can be adjusted to suit different fabrics with Balance (see Balance page 64).

All sideways motion patterns can be saved in Memory and sewn with both vertical and right/left mirror image.

To sew a sideways motion pattern as a single motif, use Pattern End 1.

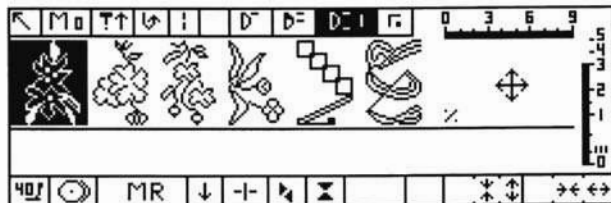

Individual sideways motion patterns can be combined to form a complete border.

Tip:

When sewing sideways motion patterns, check that the fabric can move freely so that it can be moved easily by the feed-dog.

The sewing table is advantageous for sideways motion sewing.

Templates

All sideways motion patterns, including monograms, are illustrated on the templates in their original sizes.

They are perfect for positioning the patterns in exactly the right spot on your work.

The beginning of the pattern is marked with a small hole and the end with a square. The small hole is ideal for determining needle insertion.

The sewing direction is indicated with a presser foot symbol and help lines (see inside back cover).

Sewing

Insert the needle into the hole at the beginning of the pattern and position the fabric so that the help lines on the template run parallel to the presser foot. Sew.

Transpose sideways motion patterns

In order to position sideways motion patterns next to one another, they must be programmed with the 16 directional sewing facility in Memory (see «16 directional sewing», page 61).

Combining sideways motion patterns with other stitches

Simple sideways motion patterns can be combined with other stitches. Use functions «Pattern begin» and «Pattern end».

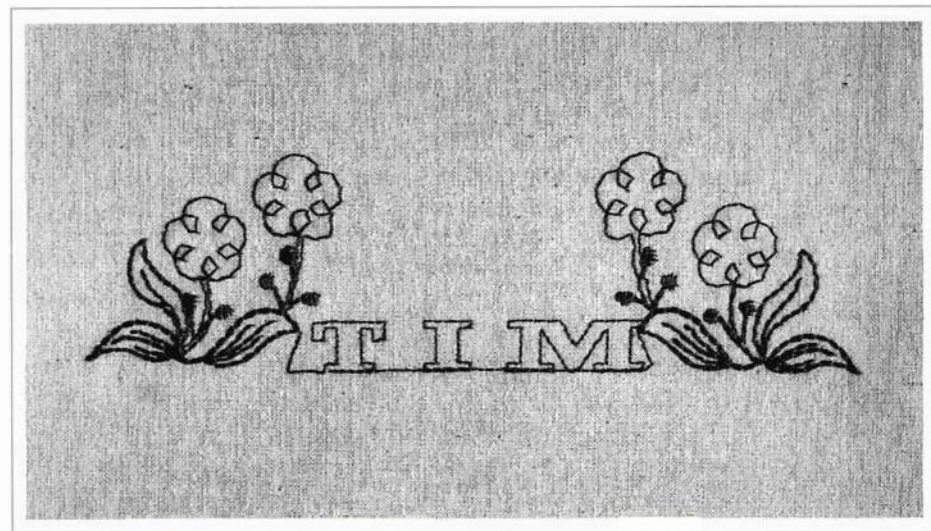

Balance

All stitches on the 1630 are sewn in and adjusted before the machine leaves the factory.

However, different fabrics, interfacings and threads can influence the stitch formation so that individual stitches do not meet or they overlap.

The electronic Balance device is incorporated to correct any deviations which may occur and to adjust the stitch to the fabrics and threads in use.

We recommend test sewing with the materials (fabric, interfacing, thread) which are going to be used for your sewing project!

Balance for practical stitches

Some knits tend to stretch under the presser foot which could result in an imperfect stitch formation, e.g. Honeycomb stitch which does not connect. In order to obtain a perfect stitch formation, the stitch must be «closed up». To do this, activate «Vertical Balance» and enter the necessary number of steps (approx. 2–5) by pressing OK. (See also «Balance for sideways motion patterns».)

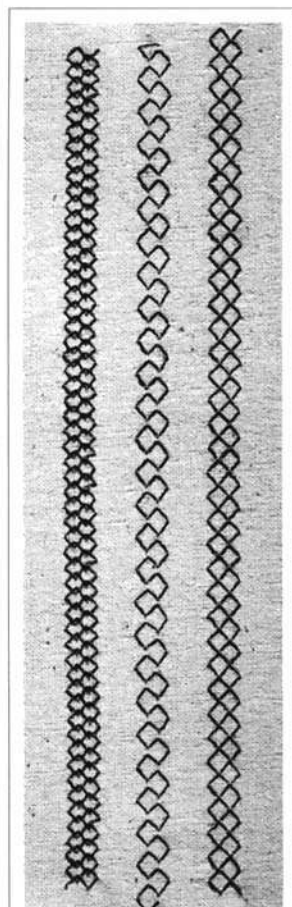

Balance for sideways motion patterns



Example palm tree (right side too short)
Lengthening a pattern.

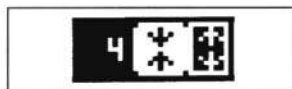

Select the arrow and enter the appropriate number of steps.

Vertical balance

Move the cursor to an arrow for Vertical Balance and press OK. The selected arrow direction will be displayed inversely. A number will appear to the left which shows the number of steps which are entered (max. 50 steps entered by pressing OK).



Approx. 1–5 steps will be necessary for vertical balance, depending on the fabric.

For difficult fabrics, more steps may be necessary. If more than 10 steps are entered, the stitch pattern will be shortened automatically.



Example palm tree (right side too long)
Shortening the length.



Select the arrow and enter the appropriate number of steps.

Balance

Horizontal balance

Move the cursor to an arrow for Horizontal Balance and press OK. The selected arrow direction will be displayed inversely. A number will appear to the left which shows the number of steps which are entered (max. 20 steps entered by pressing OK).



Approx. 5–10 steps will be necessary for horizontal balance, depending on the fabric.



Example palm tree (trunk too narrow).
Increasing the width.



Select the arrow and enter the appropriate number of steps.



Example palm tree (trunk too wide).
Decreasing the width.



Select the arrow and enter the appropriate number of steps.

Vertical and horizontal balance

Both vertical and horizontal balance may be required for some fabrics. This is possible. For perfect results, adjust the balance completely in one direction and then adjust the other direction.

Balance for zodiac signs and combinations with frame

Zodiac signs and frames can be programmed together. If the sign needs balancing, it is necessary to use Memory subdivision (see page 58) between each sign and frame as each pattern must be balanced individually. When sewing, alter the balance if necessary at the beginning of each subdivision section (first signs, then frames).

The Stitch Designer

The Stitch Designer allows you to invent your own, totally individual patterns and motifs. The creative world of sewing is truly at your fingertips!

Motifs can be sewn in any one of five different widths – 9, 18, 27, 36 and 45 mm (max. 1³/₄").

Open Stitch Designer

The symbol for the Stitch Designer (pencil) can be found in the Menu 2, screen W. Move the cursor to this symbol and press OK.

Stitch designer screen 1 = memory screen

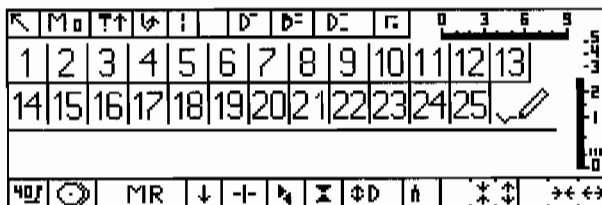

This is the stitch designer memory table. A design or motif of your own invention can be saved under each of the 25 numbers.

Each saved design can be recalled by selecting the number and pressing OK. In order to view the design, move the cursor to the pencil symbol and press OK. Your own pattern can be viewed in the stitch designer screen 2.

The saved patterns are not displayed visually on this screen.

Tip:

Keep an index of the memory contents of your own designs.

In order to create designs, move the cursor to the pencil and press OK.

Stitch designer screen 2 = design screen

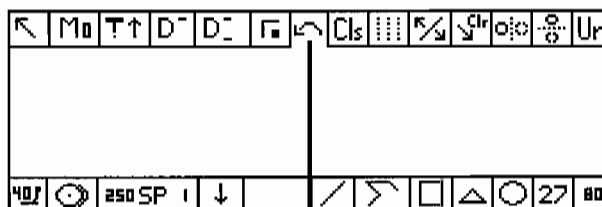

Designing

The stitch designer screen 2 consists of 2 rows of symbols. Designs are created in the right screen by moving the arrow with the command ball and then moved to the left screen which displays how the design will look when it is sewn. Any alterations to the design can be made in the left screen.

All information concerning individual symbols: see «Functions in the stitch designer» (page 69).

The available height in the screen corresponds to the pattern stitch width selected.

The sewing direction is from left to right and we recommend designing stitches from left to right.

How to design

Activate the stitch designer screen 2 (= design screen). Design grid

The design grid can be very useful for inventing your own patterns and stitches. Activate the function and the grid will appear on the screen.

If the grid symbol is activated a second time, it will be shown inversely. The arrow will move automatically from dot to dot as you draw. Ideal for keeping lines straight.

The Stitch Designer

Free drawing and drawing lines

Activate the symbol «Free drawing» or «Draw lines». You can now free draw by using the command ball to move the arrow as a pencil, or you can insert lines as and where you want. Press OK to change direction and at the beginning and end of your design. Press CLR to leave the drawing screen and select another function.

Tip:
We recommend designing from left to right, i.e. the sewing direction. Use the full height of the screen as this corresponds to the stitch width selected.

Inserting squares, triangles, or circles

Activate the desired symbol.
Press OK and move the arrow to enlarge the motif as desired. Press OK to memorise the size.

Right-left or vertical mirror image

Activate the desired symbol. After activating a dotted line will appear – the mirror axle. Use the arrow to move the axle. After positioning as desired, press OK and the pattern will be displayed in mirror image.

Cancel last mirror image

Activate the «Cancel last mirror image» symbol. This automatically erases the last mirror image entry made.

Move lines

Activate «Move lines» symbol. Select the line to be moved with the arrow and press OK. The line now appears as dots. Press OK to confirm that the correct line is activated. Then move the line with the arrow and press OK once again.

Erase lines

Activate the «Erase lines» symbol. Select the line to be erased with the arrow and press OK. The line appears as dots. Press OK again and the line will disappear.

Clear screen

Move the cursor to the «Cls» symbol and double-click OK. Both screens are cleared.

The last entered stitch can also be erased with CLR.

Transposing your design

Activate the function to move your design from the right to the left screen. The machine automatically adds the necessary connecting threads. The connecting threads can be corrected in the left screen.

Correcting connecting threads

The automatically calculated connecting threads cannot be erased but can be corrected, i.e. the unwanted threads (lines) can be transposed over existing threads (lines). Mark the line with arrow, press OK and then move the line to the desired position. Press OK to confirm.

Corrections / alterations in the design screen

If subsequent alterations are made to the motif in the right half of the screen, it must be transposed once again to the left half of the screen. If connecting threads have already been moved, these will return to their original position, i.e. previous corrections will be reverted by the programme.

Saving designs

Move the cursor to «Save» and activate. The design will be saved under the number which is visible in the «SP function» and the first screen of the stitch designer will appear. The design can be recalled at any time using the save number.

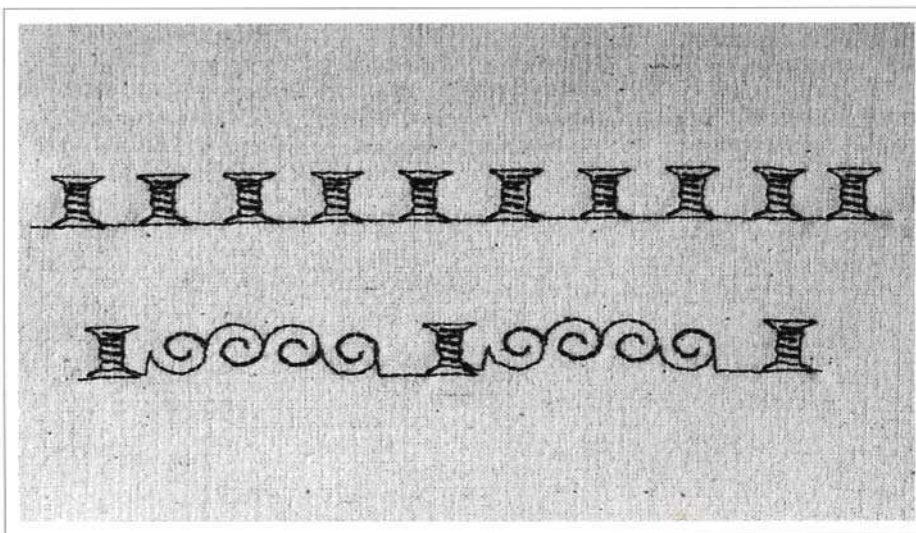

The Stitch Designer

Recalling designs from the memory

1st method:

After opening the Stitch Designer activate the appropriate number on the first screen. The design can be sewn immediately. If you want to look at the design, first activate the pencil and the design screen will appear showing the motif.

2nd method:

After opening the Stitch Designer activate the pencil symbol. Activate SP (stitch points) and press OK until the number you want is reached. The designs stored under each number will appear on the screen.

Altering designs

An already saved design can be altered and resaved.

Saving designs in the Memory

All individually created designs can be combined and saved with other stitches and motifs in the Memory.

Memory display

Stitch Designer patterns and designs are displayed under their numbers in the Memory. They appear in exactly the same form as in the Stitch Designer (= screen 1).



Pattern End Marking

When the motif is transferred from the right to the left screen, the last stitch is marked. The marking can be moved horizontally and positioned where the next motif should start.

The connecting threads which occur can now be corrected:

1. Place the cursor on line 1 and press OK.

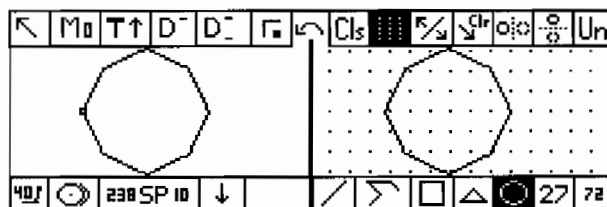

2. Move the line until the circle is closed again. Press OK. Place the cursor on line 2 and press OK.

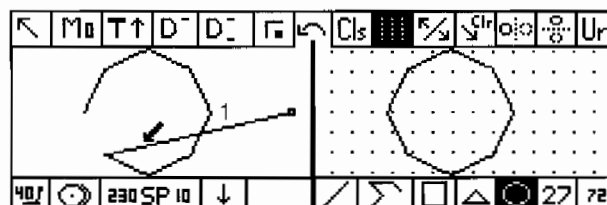

3. Move the line until it is in position 3. Press OK. Place the cursor on line 4 and press OK.

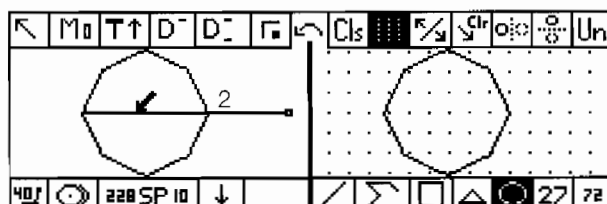

4. Move the line until it is in position 5. Press OK.

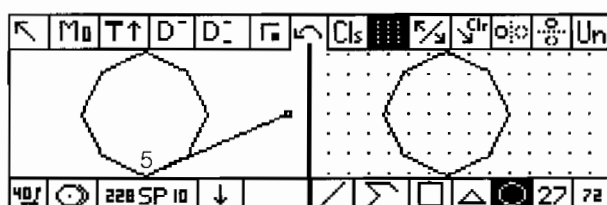
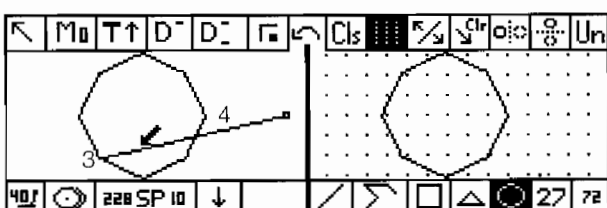

The motif, in this case a circle, will now be sewn from beginning to end without intersecting lines of connecting threads.

Note:
If the motif is subsequently transferred to the right (design) screen and altered or a new size is selected

(9/18/27/36/45), the corrections have to be repeated (see Corrections/Alterations in the design screen and Stitch Width).

Functions in the Stitch Designer

The function symbols on the right side of the screen belong to «designing». They are only active in the right half of the screen.

Clear screen

Use this function to clear the complete screen. Move the cursor to the function symbol and double-click OK. If a pattern has been recalled from the memory, it will be erased.



Grid

After activating this symbol, a grid appears in the right half of the screen to help you create your designs. After activating a second time, the cursor automatically moves from dot to dot. The symbol is now displayed inversely.



Move line

A wrongly placed line can be moved.



Erase line

A wrongly placed line can be erased.



Mirror image right-left

After activating this function, a vertical dotted line appears on the screen – the mirror axle. This can be moved as desired with the arrow. After positioning the mirror axle, press OK and the design will be automatically displayed in mirror image.



Vertical mirror image

After activating this function, a horizontal dotted line appears on the screen – the mirror axle. This can be moved as desired with the arrow. After positioning the mirror axle, press OK and the design will be automatically displayed in mirror image.



Cancel last mirror image

After activating this function, the last mirror image will be cancelled.



Draw lines

Individual lines can be drawn. Press OK at the beginning, for each change of direction and at the end.



Free drawing

The complete screen can be used for free drawing. Confirm changes of direction with OK.



Insert square

A square can be inserted into your design. Press OK to insert and use the arrow to enlarge as desired.



Insert triangle

A triangle can be inserted into your design. See squares.



Insert circle

A circle can be inserted into your design. Set the centre point with OK and enlarge with the arrow.



Stitch width

Patterns and motifs can be created and sewn in 5 different widths: 9, 18, 27, 36 and 45 mm (max. 1 $\frac{3}{4}$ "'). On opening the Stitch Designer the number 27 (= 27 mm stitch width) appears on the screen. Press OK to select any one of the five stitch widths. If you subsequently select a different width, the motif must be transposed once again to the left side of the screen.



Number of lines available

There are 80 lines for each design (stitch/motif). This number shows the number of lines still free.



Move design

The design will be moved from the right to the left screen. The machine automatically calculates the necessary number of connecting threads which can be corrected if wanted.



The function symbols on the left side of the screen belong to «sewing». They are only active in the left half of the screen.

Back to Menu

Activate this function to return to Main Menu 1.



Sewing speed (1/3, 2/3 and 3/3)

The machine sews at the speed selected even when the foot control is fully depressed. The maximum speed can be limited for any stitch with the exception of sideways motion stitches. The speed selected appears on the screen.

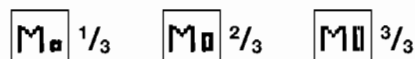

Needle stop up/down

The arrow next to the needle symbol shows where the needle generally stops. The needle stop can be altered from up to down (and reverse).



Pattern begin

After activating this function the machine switches automatically to pattern begin.



Pattern end 1-9x

The machine stops at the end of an individual stitch/motif or at the end of a chosen number of stitches/motifs (2-9).



Securing

The machine automatically sews 3 securing stitches at the beginning and end of an individual stitch or stitch combination.



Functions in the Stitch Designer



Presser foot indicator

The most suitable presser foot will be displayed.



Bobbin thread control

The symbol inverts and starts to blink when the bobbin thread is running short (approx. 2–5 m/yds, depending on the thickness).

250 SP 25

Stitch points

The number of free stitches (max. 250) is displayed to the left of SP (= stitch points). The number on the right shows the memory number (1–25). These numbers correspond to the numbers in the memory screen (= Stitch Designer screen 1).

When OK is pressed, the next memory will be recalled and the contents displayed on the screen.



Save and return to Stitch Designer screen 1

Created designs are saved under a memory number which is visible in SP. The Stitch Designer screen 1 is activated simultaneously.



Pattern extension

The length of the motif will be doubled. This function only applies to the 9 mm stitch width.

Threads Needles

Needles and sewing machine

1. Needles and sewing machine

Your Bernina uses needle system 130/705H. Make sure you buy this system when replacing needles. Needles are available in sizes 70 to 120. The finer the needle, the lower the number. The opposite applies to thread – the finer the thread, the higher the number.

The table below shows which needle should be used for which thread.

2. Needle and thread

The needle size required depends on the thread selected. The needle must suit the thread.

When sewing, the thread lies in the long groove of the needle (fig. 1). If the needle is too fine, the thread will not fit into the groove (fig. 2) and faulty stitching will occur.

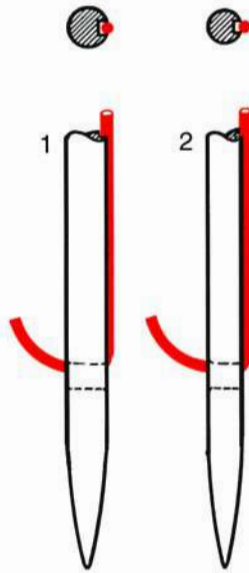

3. Needle and fabric

Needle condition

Hard, closely woven fabrics sometimes require a stronger needle than those shown in the Needle/thread table in order to achieve perfect stitch formation on both sides of the fabric.

The needle must be in perfect condition.

Sewing problems are caused by:

- bent needles (A)
- blunt needles (B)
- hooked tips (C)

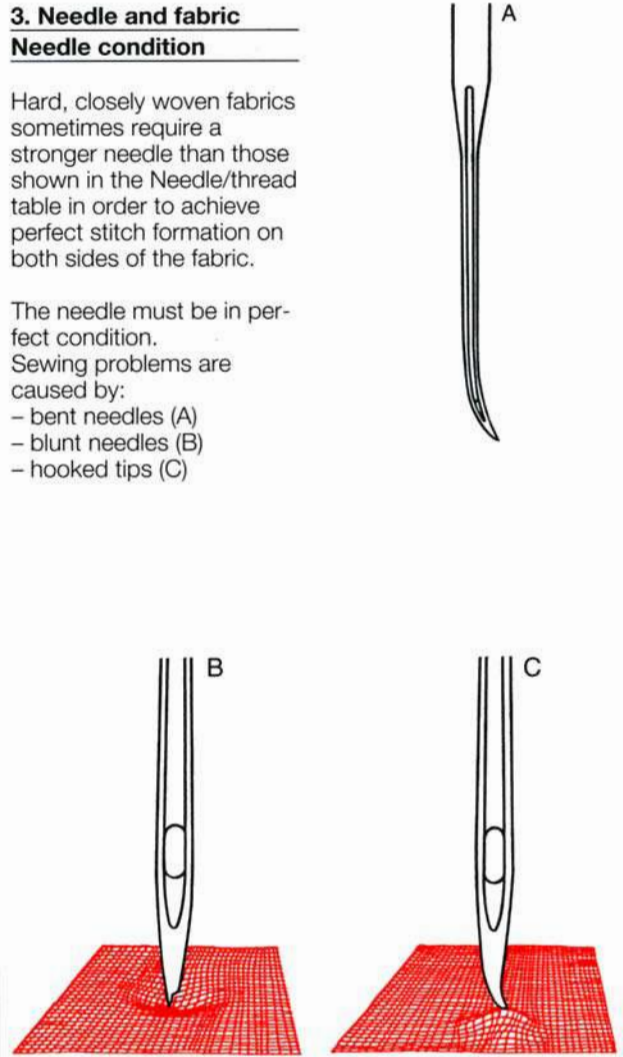





Needle/thread table

| Needle | 70 | 80 | 90 | 100 | 110-120 |
|--|----|----|----|-----|---------|
| Darning thread | * | * | | | |
| Embroidery thread no. 30 | | * | | | |
| Sewing thread Mercerised cotton | | * | * | | |
| Synthetic sewing thread | | * | * | | |
| Coarse mercerised cotton Mercerised synthetic | | | * | * | |
| Buttonhole thread for top stitching (Cordonnet) | | | | * | * |

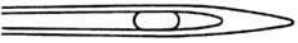
Sewing machine needles

The modern domestic sewing machine is capable of handling a large variety of fabrics. However, as in industry, special needles are required for different fabrics, e.g. needles with various different points.

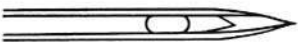
| Table of special needles | Needle description | Needle point | Suitable for |
|--------------------------|---------------------|---|--|
| Standard needle | 130/705 H | Normal point, slightly rounded  | Universal needle for woven synthetic and natural fibres, e.g. linen, chiffon, batiste, organdie, wool, velvet. |
| Special needles | 130/705 SES | Fine ball point  | Fine knitted fabrics made from silk, synthetics, cotton and fine wool. |
| | 130/705 H-SUK | Medium ball point  | Heavier knitted fabrics in synthetic or natural fibres. |
| | 130/705 H-S | Medium ball point  | Special needle for delicate of difficult stretch fabrics. |
| | 130/705 H-J | Extra fine point  | Overalls, heavy linen, denim, canvas. Pierces dense fabrics easily. |
| | 130/705 H-LR + H-LL | Cutting point  | Leather, suede, calfskin, pigskin, imitation leathers and suedes, plastics. |

Fabric feed and height compensation

1. Fabric feed and stitch length

With each stitch the feed-dog moves forward by one step.

The length of this step is governed by the stitch length selected. With an extremely short stitch length, the steps are also short. The fabric moves under the foot quite slowly, even at full sewing speed. Buttonholes, satin stitch and decorative stitches are all sewn with a short stitch length.

Important:

- a) Make sure that the fabric feeds evenly.



- b) Pushing will result in gaps.

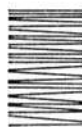

- c) Holding back will result in pile-ups.

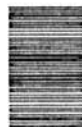

2. Fabric feed and height compensation

The height compensating plates guarantee perfect fabric feed when sewing thick areas and topstitching edges. One, two or three compensating plates can be used depending on the thickness (height).

- a) The feed-dog can only work properly when the presser foot is flat.



- b) When sewing thick areas, the presser foot is forced upwards which does not allow the feed-dog to grip and feed the fabric correctly.

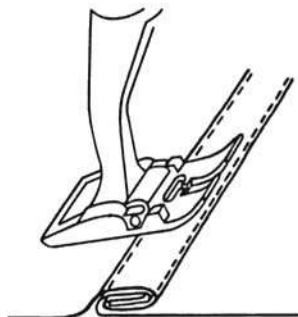

- c) To compensate for the height (thickness), place one, two or three compensating plates behind the needle under the presser foot.



- d) To compensate in front of the presser foot, place one or more plates to the right of the foot flush with the needle. Sew over the thick area and then remove the plates.

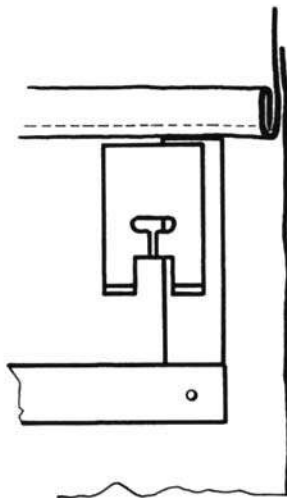

3. Fabric feed and sewing corners

- a) The two rows of teeth of the feed-dog are quite a distance apart because of the width of the zig-zag needle hole.



- b) When sewing corners, only a small part of the fabric is actually on the feed-dog so it cannot feed the work correctly.

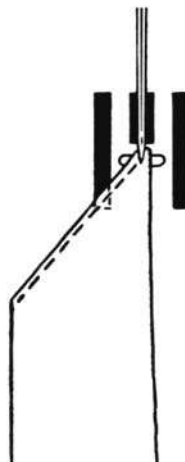

- c) For an even feed, place one or more plates to the right of the presser foot flush with the fabric edge.

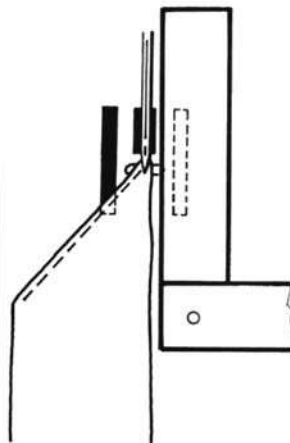

Trouble shooting Maintenance

Fault prevention

If your sewing machine does not work properly, it is usually due to incorrect operation.

Check whether:

The upper and lower threads are correctly threaded.
The needle is inserted correctly with the flat side of the shank to the rear.
The needle size is correct. See needle and thread table.
The machine is clean. Brush out any remnants of thread or lint.
The hook race is clean and oiled.
Any remnants of thread are trapped between the tension discs and beneath the bobbin case spring.

Upper thread breaks

The upper tension is too tight.
Poor quality needles. Ideally, needles should be purchased from a Bernina dealer.
The needle has been fitted incorrectly. The flat side of the shank must be to the rear.
The needle is blunt or bent.
Poor quality thread, knotted or dried-out thread.

Lower thread breaks

The lower thread tension is too tight.
The bobbin is jammed in the bobbin case. Replace the bobbin.
The hole in the stitch plate has been damaged. This must be repolished professionally.
The needle is blunt or bent.

Faulty stitching

Wrong needles. Use only the 130/705H needle range.
The needle is blunt or bent or incorrectly fitted. Push right to the top when inserting.
Poor quality, badly polished needle.
The needle point does not suit the fabric being sewn. If necessary, use ball point for knitted fabrics and cutting point for hard fabrics.

Needle breaks

Needle clamp screw not sufficiently tightened.
Fabric withdrawn forwards instead of to the back.
When sewing over a thick area, the fabric was pushed with the needle still in it.
Use the Jeans foot.
Poor quality thread, unevenly wound or knotted.

Faulty tension

Remnants of thread between the tension discs.
Remnants of thread under the bobbin case spring.
Threaded with the foot down.
Incorrectly threaded – check lower and upper threads.

Machine fails to sew full zig-zag width

Check if «Double Limitation» function (26) has been activated.

Machine fails to run or only runs slowly

Plug not inserted correctly.
Power switch on «0».
Sewing speed 1/3 or 2/3 activated.
Unsuitable oil used.
Machine must be cleaned by a specialist.
Machine has been standing in a cold room.
Bobbin winder switched on.

Machine sews in reverse

Function «Reverse Sewing» (25) is activated.

Machine does not sew selected stitch

Unwanted functions are activated.
Stitch length/width has been altered (individual settings stored).

Programme is erased

Machine was disconnected from electricity supply without leaving with «Save/leave Memory» function.

Cursor does not move

Clean the command ball (see page 79).

If you need to take your machine to be serviced or repaired, always take the foot control and accessories.

Changing the bulbs

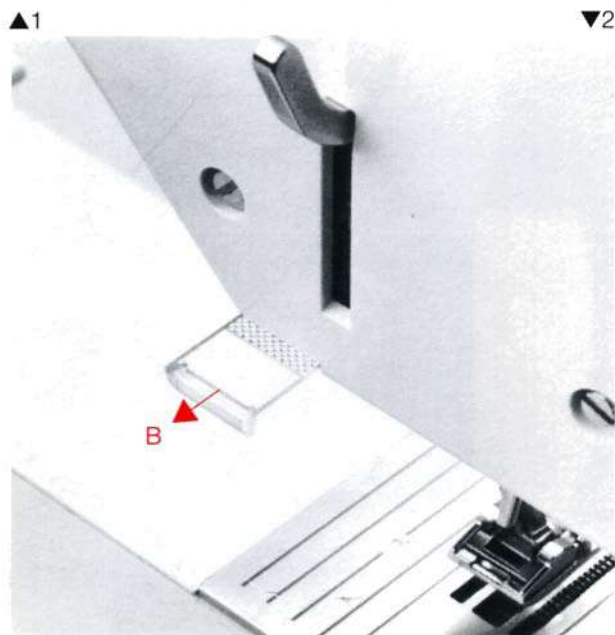
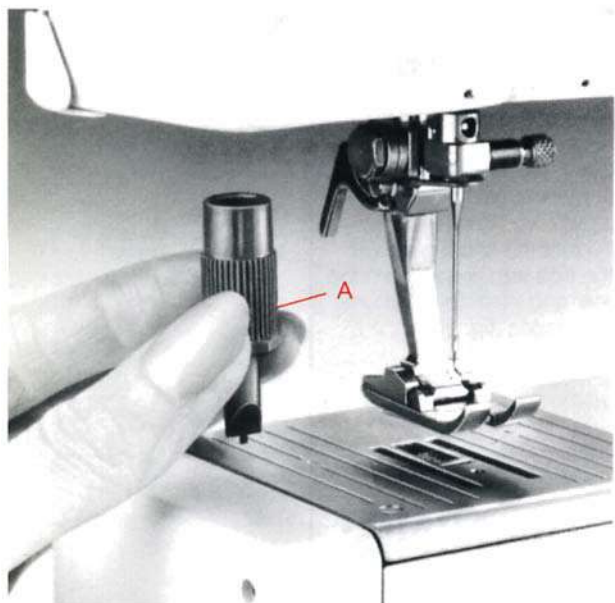
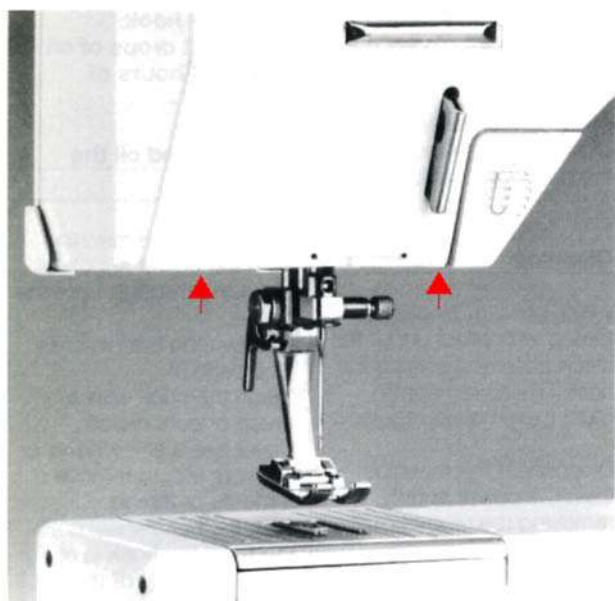

Fitting the bulbs

Your machine is equipped with 2 low voltage 6 volt/4 watt bulbs. The first is located in front of and to the left of the presser foot. The other is behind the foot to the right.

WARNING:

Please refer to the safety instructions.

Changing bulbs

To change the front bulb (fig. 1):
Using the special gadget A, press the bulb upwards, twist to the left and remove.

To change the rear bulb (fig. 2):

Remove the diffuser B. The bulb can then be removed in the same way as above.

To insert new bulbs

Place the new bulb on the gadget (fig. 3), insert into the holder, press upwards and twist to the right until it clicks into place. After replacing the rear bulb, refit the diffuser B.

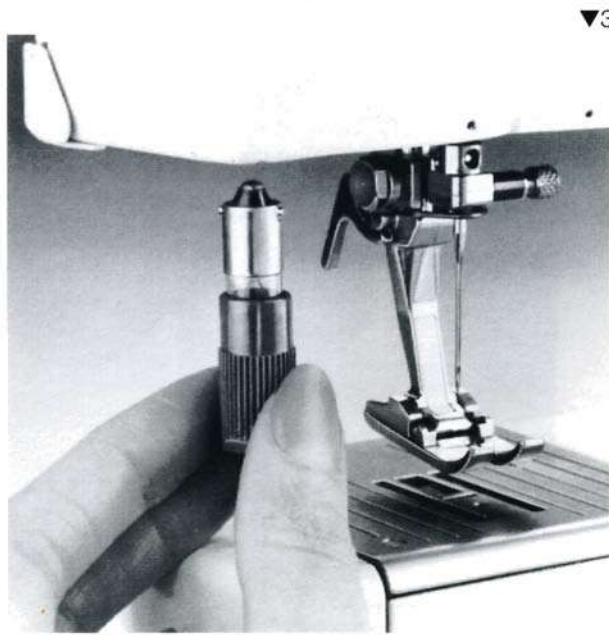

Maintenance: Cleaning and oiling

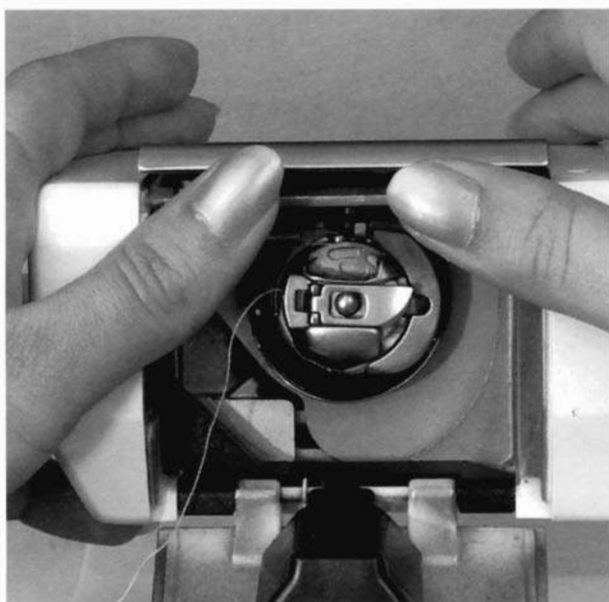

▲1

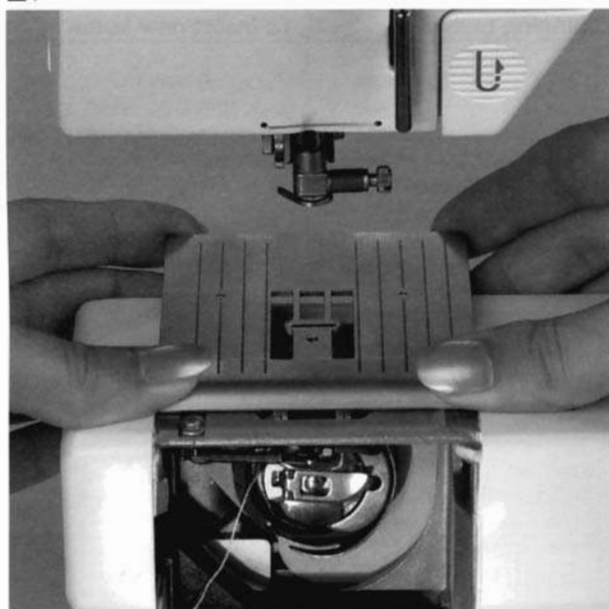

▲2

▼3

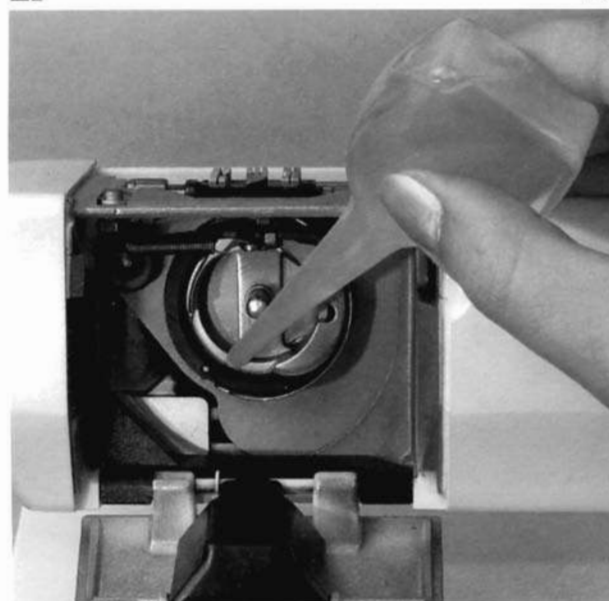

If the machine has been stored in a cold room, it should be brought to a warm room approximately one hour before use in order to restore the oil in the bearings to a fluid state.

Cleaning

When sewing, pieces of thread will collect under the stitch plate and around the hook. These remnants must be removed regularly.

Disconnect the machine from the power supply by removing the plug from the socket.

Remove the presser foot and the needle.

Open the hinged front cover on the free arm. Lower the feed-dog. Set knob to position . Using both thumbs, press the stitch plate up and back (fig. 1).

Clean the feed-dog and underside of the stitch plate.

To refit the stitch plate on the free arm, insert from the rear and push forward until it engages (fig. 2).

To oil the hook:
Apply 1–2 drops of oil after 3–4 hours of sewing.

To clean and oil the hook

Disconnect the machine from the power supply by removing the plug from the socket.

Remove the bobbin case (see page 6).

Clean the hook with a brush or cotton cloth.

Never use a screwdriver or scissors etc. to remove remnants or thread.

Turn the handwheel until the tip of the hook is at the bottom. Lightly oil the hook race (fig. 3).

Replace the bobbin case (fig. 4).

WARNING:

Please refer to the safety instructions.

▼4

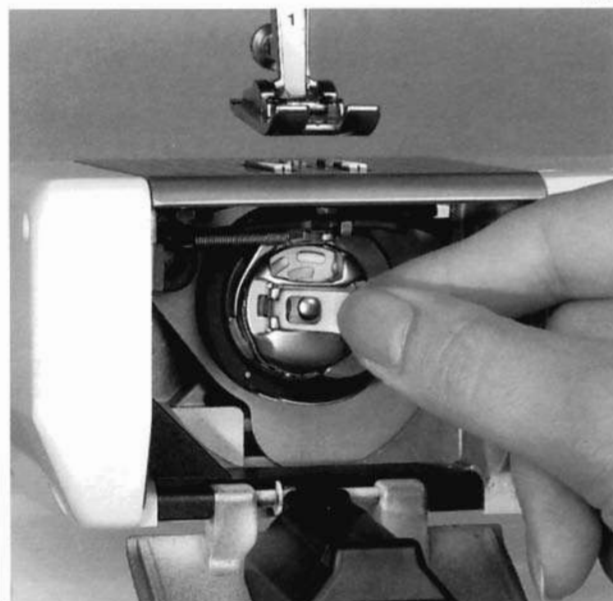

Maintenance: Cleaning the command ball and screen

Cleaning the command ball

After a long period of use, the command ball may be affected by dust and the natural oils present on the skin of fingers and hands. This can affect the movement of the cursor which can become erratic. Should this occur, it is necessary to clean the command ball.

Use a soft, damp (not wet), smooth fibre cloth.
Use only tap water.

If it is very dirty, add a few drops of mild washing-up liquid to the water.

Important:

- Do not use solvents in any form!
- Do not use any type of powder or abrasive cleaner!
- Do not push anything between the command ball and housing!
- Do not remove the command ball!

Cleaning the screen and housing

Clean in the same way as the command ball.

Important:

If the screen is damaged or breaks, a liquid can escape. If this comes into contact with the skin, wash thoroughly with soap and water.

Remove the protective film on the screen

A film protects the screen from scratches during assembly and transport. Remove the film before using your machine for the first time.

Bernina Publications

Bernina Publications

It is impossible to cover all aspects of sewing in an instruction manual. For this reason, Bernina offers a variety of interesting and informative publications which enable you to get the most out of your sewing machine. From basic sewing techniques to creative masterpieces, you will always find something new and exciting to make with your Bernina sewing machine or overlocker. Ask your Bernina dealer to show you some of our publications and let yourself be inspired.

Bernina Sewing Service Leaflets

Our Sewing Service Leaflets are the perfect complement to our magazine and Collection brochures. They explain important basic sewing techniques and offer simple solutions for using special presser feet on Bernina sewing machines and overlockers. Ideal for improving sewing knowledge and skills.

Bernina Creative Sewing

Bernina Creative Sewing, our international sewing magazine, is published twice yearly and contains new and exciting sewing ideas. As well as Bernina specific interpretations of the latest fashions, quick and easy sew «Couture Rapide» and special designs for the younger generation, the magazine deals with a variety of other popular topics. Home decoration and special sewing techniques such as quilting, patchwork or creative machine embroidery are regular features. Particular attention is given to instruction and selected projects are described in step-by-step photo sequences which best illustrate modern sewing on a Bernina sewing machine or overlocker.

Bernina Collection

The Bernina Collection is a range of booklets which deal with the latest sewing trends. Each Collection covers one particular theme with a variety of creative examples. Twelve pages in full colour with pattern sheets where appropriate, offer a wealth of background information, fabric and pattern suggestions, ideas for individual design solutions and tips and tricks of the trade for professional results. Comprehensive and fully illustrated step-by-step instructions for Bernina sewing machines and overlockers and for special presser feet guarantee sewing success.



Index

Index

| | | | | | | | |
|---------------------------|-------|--------------------------|-------|---------------------------|-------|---------------------------|-------|
| A | | – programming | 57 | – Stitch points (SP) | | K | |
| Accessories | 3 | – altering the basic | 23 | Function symbols | 25/26 | Keyhole buttonhole | |
| Accessory box | 3 | settings | 66 | – Back to menu | | – reinforced | 50 |
| – attaching | 3 | Designing | 62 | – Balance | | Knitted fabrics, sewing | 34 |
| – removing | 3 | Directional sewing | 26 | – horizontal | | | |
| Alphabet | 13 | Double needle limitation | 32 | – vertical | | | |
| – double block | 13 | Double overlock | 32 | – Basting stitch | | L | |
| – single block | 13 | Double overlock seam | 32 | – Bobbin control | | Leather | 17 |
| – script (capitals) | 14 | Drop feed-dog | 5 | – CLR button | | Letters, alphabet | |
| – script (small) | 14 | Draw lines | 69 | – Drop feed-dog | | – programming | 57 |
| Animals | 14 | | | – Double needle | | Long stitch | 25 |
| Automatic buttonhole | 49 | E | | limitation | | Lower thread | |
| Automatic mending | 40/44 | Edge stitching | 30 | – 1/2 pattern | | – breaks | 76 |
| | | Edges, oversewing | 30 | – Long stitch | | – bringing up | 6 |
| B | | Edging stitches | 30 | – Memory | | – winding | 6 |
| Balance | 64 | Edging with elastic | 39 | – Memory subdivision | | | |
| – horizontal | 65 | Elastic | | – Mirror image right-left | | M | |
| – vertical | 64 | – sewing on | 38/39 | – Mirror image vertical | | Machine | |
| Basic settings | 23 | – shirring elastic | 38/45 | – Needle stop | | – fails to run | 76 |
| – altering | 23/29 | Erase | | – Next screen | | – fails to sew full width | 76 |
| – combining with | | – lines | 69 | – Pattern begin | | – stitching in reverse | 76 |
| functions | 23 | – memories | 59 | – Pattern end | | – runs slowly | 76 |
| – restoring | 23 | – stitches | 58 | – Pattern extension | | Mains cable | |
| Basting stitch | 36 | Eyelet programme | 51 | – Presser foot indicator | | – connecting | 4 |
| Blind hemming | 37 | | | – Previous screen | | Marking buttonholes | 46/48 |
| Blind stitch | 17 | F | | – Reverse sewing | | Memory | 56 |
| Bobbin case and bobbin | 6 | Fault prevention | 75 | – Save/leave Memory | | Menus | 12–15 |
| Bobbin control | 7 | Faulty stitches | 76 | – Sewing speed | | Mending | |
| Bobbin winding | 6 | Faulty tension | 76 | – Securing button | | – interlock fabric | 45 |
| Borders | 14 | Feed-dog | | – Single pattern | | stitch | 43 |
| Buttonholes | 19 | – lowering | 9 | (pattern end) | | – woven fabrics | 43 |
| – standard buttonholes | 46 | – and fabric feed | 74 | – 16 directional sewing | | Mirror image | |
| – stretch buttonholes | 46 | – and presser feet | 74 | G | | – right-left | 25 |
| – round buttonholes | 48 | – and sewing corners | 74 | Geometric stitches | 12 | – vertical | 25 |
| – keyhole buttonholes | 48 | – and stitch length | 74 | Gimp – buttonholes | 46 | Motor | 4 |
| – with gimp | 46 | Flat joining seam | 31 | Grid | 66/69 | Move design | 69 |
| – cutting | 47 | Floral stitches | 13 | H | | Move line | 69 |
| – fully automatic | 49 | Foot control | | Hems, visible with | | N | |
| – reinforced | 50 | – connecting | 4 | – Jersey stitch | 33 | Neckband | |
| Buttons | | – and electronic needle | 4 | – Triple zig-zag | 33 | – with decorative seam | 34 |
| – sewing on | 51 | stop | 4 | Hems, practical stitch | 33 | – with overlock seam | 34 |
| | | Free drawing | 67 | Honeycomb stitch | 34 | Needle | |
| C | | Functions | 25/26 | Hook | 78 | – and fabric | 72 |
| Cancel | | Functions in Stitch | | I | | – and sewing machine | 72 |
| – last Mirror Image | 69 | Designer | 69/70 | Inserting the bobbin | 6 | – and thread table | 72 |
| Case | 2 | – Back to Menu | | Insert | | – breaks | 76 |
| Changing the bulbs | 77 | – Bobbin thread control | | – circle | 69 | – inserting | 10 |
| Cleaning and oiling | 78 | – Clear screen | | – square | 69 | – positions | 23 |
| CLR (clear) button | 22 | – Draw lines | | – triangle | 69 | – quick threader | 8 |
| CLS (clear screen) | 69 | – Erase lines | | Insert stitches | | – standard | 73 |
| Coded feet | 16 | – Free drawing | | programming | 57 | – special | 73 |
| Command ball | | – Grid | | Interlock fabric, mending | 45 | Needle stop | 4 |
| – cleaning | 79 | – Insert circle | | J | | Numbers | |
| Compact stitches | 12 | – Insert square | | Jeans foot | 16 | – programming | 57 |
| Contrast button | 24 | – Insert triangle | | Jersey stitch | 17 | | |
| Corrections | | – Mirror image | | | | O | |
| – in memory | 57 | – right-left | | | | Oiling and cleaning | 78 |
| Cross stitches | 54 | – vertical | | | | OK button | 22 |
| Cursor | 22 | – cancel last | | | | Open seams | 31 |
| | | – Move design | | | | Overlock seams | 32 |
| D | | – Move lines | | | | Overlock stitches | 32 |
| Darning | | – Needle stop | | | | Oversewing edges | 30 |
| – with small darning ring | 42 | – Pattern begin | | | | | |
| Decorative stitches | | – Pattern end | | | | | |
| – combining | 57 | – Pattern extension | | | | | |
| | | – Save | | | | | |
| | | – Securing | | | | | |
| | | – Sewing speed | | | | | |

Index

| | | | |
|--------------------------|---------------------------|-------|------------------------|
| P | | | |
| | – stretch | 31 | Stretch stitch |
| | – stretch overlock | 32 | |
| Patching using | – triple straight stitch | 31 | |
| – Automatic mending | – vari-overlock | 34 | |
| – Honeycomb stitch | – zig-zag | 28 | |
| – Jersey stitch | Securing stitch button | 26 | T |
| Pattern begin | Sewing light | | Thread |
| Pattern end | – changing bulb | 77 | – bringing up lower |
| Pearl stitches | Sewing machine | | – cutter |
| Power cord | needles | 72/73 | – needles |
| Power switch | Sewing speed | 25 | – upper thread |
| Practical stitch hems | Sewing table | | Thread tension |
| Practical stitch seams | – attaching | 5 | Thread, lower |
| Practical stitches | – removing | 5 | – breaks |
| – forward sewing | Sewing thick fabrics | 36 | – bringing up |
| – reverse sewing | Sideways motion stitches | | Thread, upper |
| – menus | – flowers | 13 | – breaks |
| Presser feet | – animals/trees | 13 | – threading |
| – Blind stitch foot | – monograms | 14 | Top stitching |
| – Buttonhole foot | – zodiac signs | 13 | – using buttonhole |
| automatic | Special needles | 73 | thread |
| – Button sewing-on foot | Standard buttonholes | 46 | Triple straight stitch |
| – Coded buttonhole foot | Stitch designer | 66 | Triple straight seam |
| – Coded open | Stitch length, adjust | 23 | Triple zig-zag |
| embroidery | Stitch width, alter | 23 | Turn fabric |
| – Coded reverse pattern | Stitches | | |
| foot | – altering basic settings | 29 | U |
| – Coded sideways | – combining with | | Universal stitch |
| motion | functions | 57 | Upper thread |
| – changing | – animals | 14 | – breaks |
| – Darning foot | – compact | 12 | – threading |
| – Jeans foot | – edging | 13 | |
| – Overlock foot | – floral | 13 | |
| – Zip foot | – flowers | 13 | |
| Presser foot indicator | (sideways motion) | | V |
| Presser foot lifter | – large edging stitches | 13 | Vari-overlock |
| – attaching | – pearl | 12 | Vari-overlock seam |
| – lowering the feed-dog | – faulty stitches | 76 | Vehicles (patterns) |
| Prevention, faults | – forward sewing | 28 | Visible hem |
| Programming | – practical stitches | 12 | – Jersey stitch |
| Publications | – trees | 13 | – Triple zig-zag |
| | – Blind stitch | 17 | |
| | – Running stitch | 43 | |
| | – Sideways motion | 63 | |
| | – Straight stitch | 28 | W |
| | – Stretch stitch | 31 | Woven fabric |
| | – Universal stitch | 38 | – mending |
| | – Vari-overlock | 34 | |
| | – Zig-zag | 28 | |
| | – reverse sewing | | Z |
| | practical | 28 | Zig-zag seam |
| | – Double overlock | 32 | Zig-zag stitch |
| | – Honeycomb | 34 | – triple |
| | – Jersey | 33 | Zip foot |
| | – Stretch overlock | 32 | Zips |
| | – Triple straight | 31 | Zodiac signs |
| | – Triple zig-zag | 33 | |
| | Stitching | | |
| | – edging | 30 | |
| | – forward | 28 | |
| | – needle positions | 23 | |
| | – reverse sewing | 25 | |
| | – sideways motion | 63 | |
| | – top stitching | 36 | |
| | Straight stitch | 28 | |
| | Stretch overlock | 32 | |
| | Stretch seam | 31 | |
| | | | |
| R | | | |
| Reduced sewing speed | | | |
| Reverse sewing | | | |
| Reverse sewing function | | | |
| Reinforcing | | | |
| – mends | | | |
| Reinstate basic settings | | | |
| Running stitch | | | |
| | | | |
| S | | | |
| Safety instructions | | | |
| Save/Leave Memory | | | |
| Satin stitch | | | |
| Screen | | | |
| – cleaning | | | |
| – contrast | | | |
| Seams | | | |
| – double overlock | | | |
| – flat joining | | | |
| – open | | | |
| – overlock | | | |

WARNING:

Please refer to the safety instructions.

Sollte diese Maschine in ein anderes Sprachgebiet verkauft werden, fordern Sie beim nationalen Importeur oder Bernina Händler eine Bedienungsanleitung in der entsprechenden Sprache an.

If this machine has been purchased in a foreign country, please request an instruction manual in your own language from the national Importer or a Bernina dealer.

Si cette machine est vendue dans une autre région linguistique, demandez à l'importateur national ou à l'agent Bernina, un manuel d'instructions dans la langue correspondante.

In caso questa macchina fosse venduta in un territorio di lingua diversa si prega di richiedere il libretto d'istruzione nella lingua adeguata presso l'importatore nazionale oppure presso un rivenditore Bernina.

Si esta máquina se vende en otra región lingüística entonces pida Vd. de su importador nacional o del representante Bernina un manual de instrucciones en el idioma correspondiente.

Indien deze machine in een ander taalgebied werd gekocht, kunt u bij de nationale importeur of Bernina vakhandelaar een handleiding in de overeenkomstige taal aanvragen.

Skulle denne maskine blive solgt i et andet sprogområde, bedes du henvende dig hos den nationale Bernina-importør eller en Bernina-forhandler, hvor du kan købe en brugsanvisning på det ønskede sprog.

Om den här maskinen har köpts i ett annat land, var vänlig beställ en instruktionsbok på Ditt eget språk från importören eller en Bernina-återförsäljare.

Er denne maskinen kjøpt i utlandet, kan instruksjonsbok bestilles på ditt eget språk fra Bernina importøren eller nærmeste Bernina forhandler.

Tarvittaessa voit tiedustella omakielistäsi käyttöohjekirjaa Bernina-maahantuojalta tai jälleenmyyjältä.

Se esta máquina foi comprada num país estrangeiro, dever-se-à pedir o manual de instruções naquela língua ao importador nacional ou ao forneoedor da Bernina.

ΑΝ Η ΜΗΧΑΝΗ ΕΧΕΙ ΑΓΟΡΑΣΤΕΙ ΣΕ ΜΙΑ ΞΕΝΗ ΧΩΡΑ, ΠΑΡΑΚΑΛΩ ΖΗΤΗΣΤΕ ΕΝΑΝ ΟΔΗΓΟ ΛΕΙΤΟΥΡΓΙΑΣ ΣΤΗΝ ΔΙΚΗ ΣΑΣ ΓΛΩΣΣΑ ΑΠΟ ΤΟΝ ΓΕΝΙΚΟ ΑΝΤΙΠΡΟΣΩΠΟ ΤΗΣ BERNINA Η ΑΠΟ ΤΟΥΣ ΠΩΛΗΤΕΣ ΤΗΣ BERNINA.

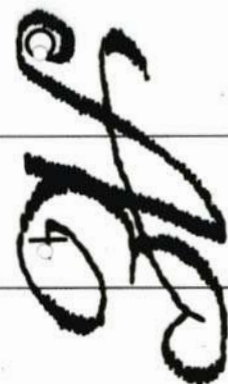
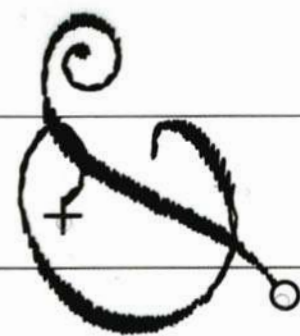

BERNINA 1630

○ - START + - END

○ - START + - END

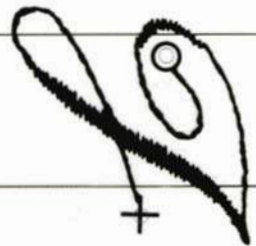
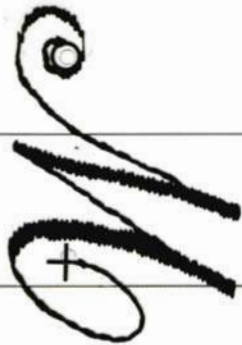
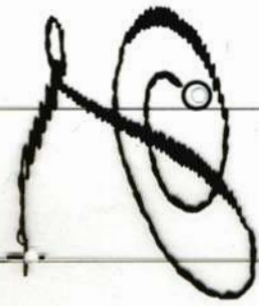

BERNINA 1630

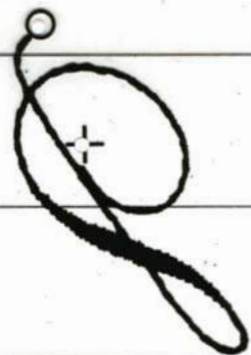
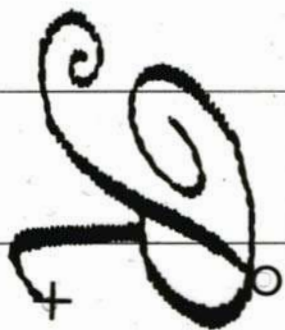
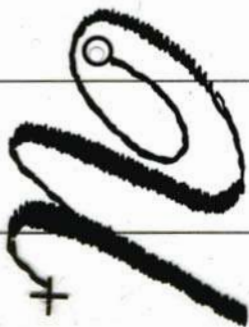
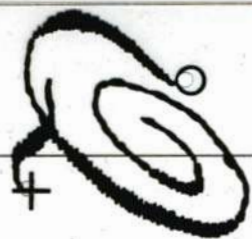

○ - START + - END

BERNINA 1630

- 0 |
- 1 |
- 2 |
- 3 |
- 4 |
- 5 |
- 6 |
- 7 |
- 8 |
- 9 |
- 10 |
- 11 |
- 12 |
- 13 |
- 14 |
- 15 |
- 16 |
- 17 |
- 18 |
- 19 |
- 20 |

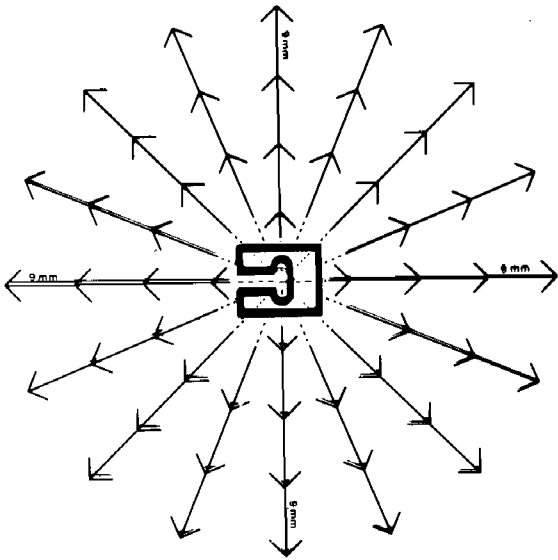

BERNINA 1630

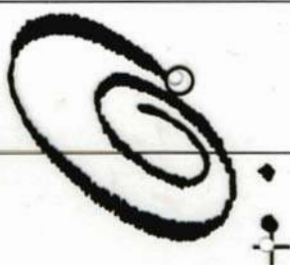
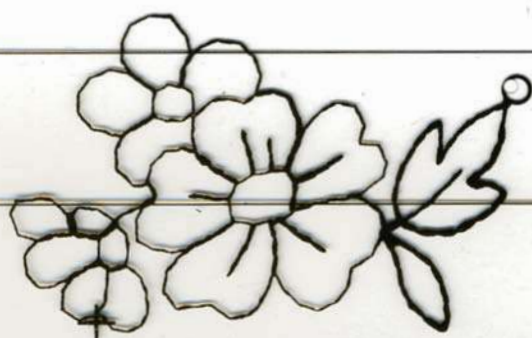
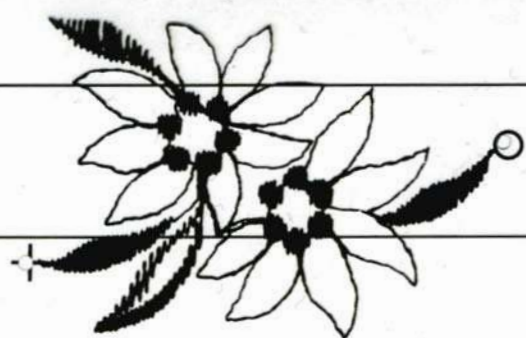

○ - START + - END



BERNINA 1630

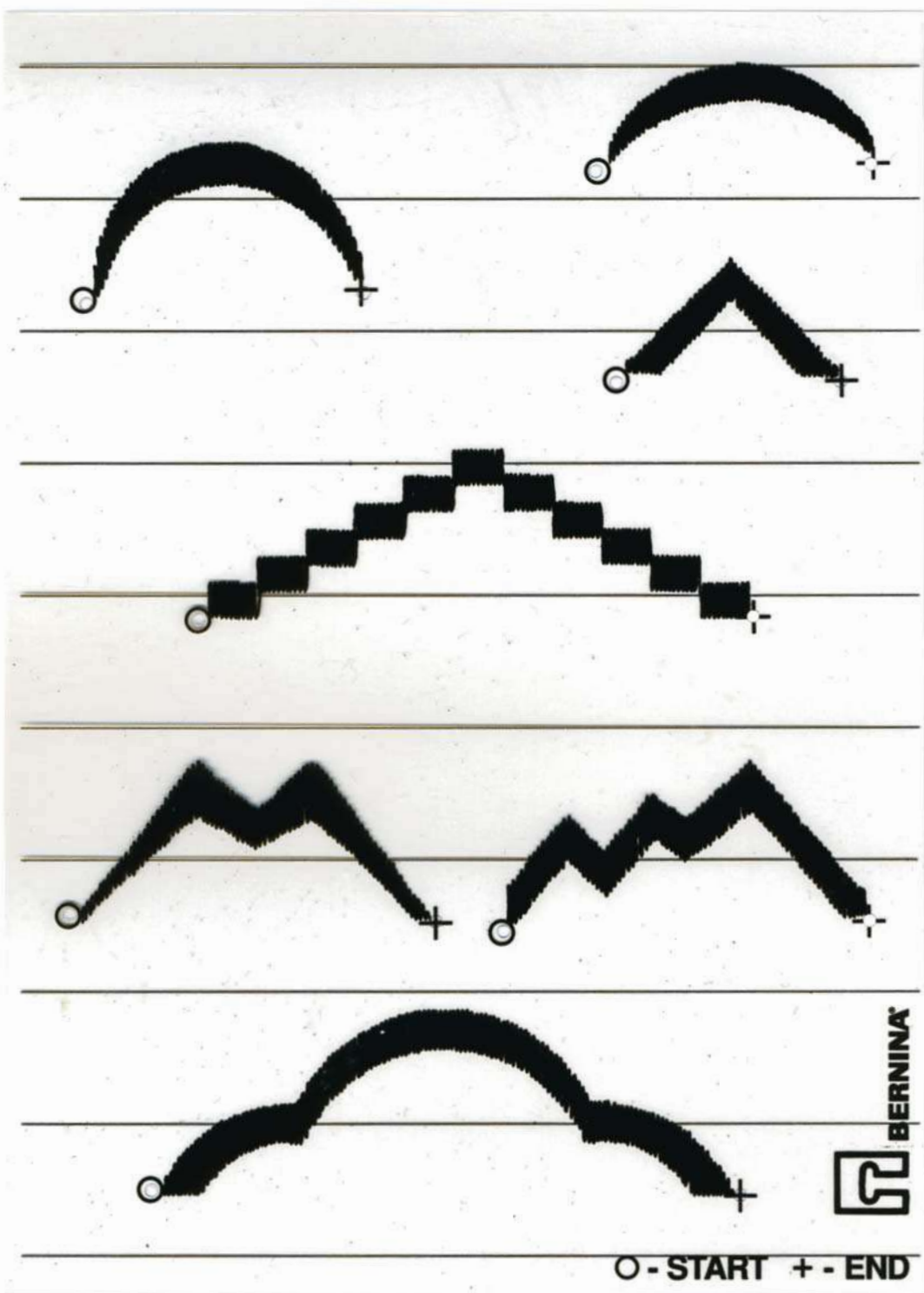

 BERNINA

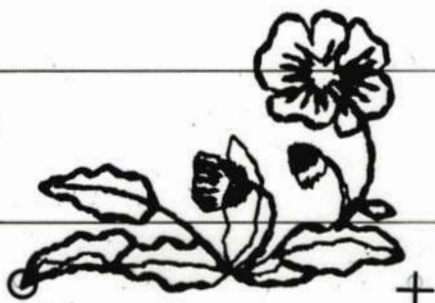
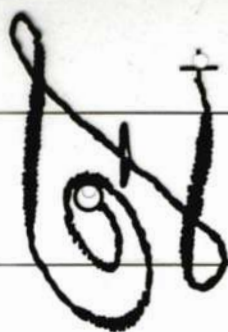
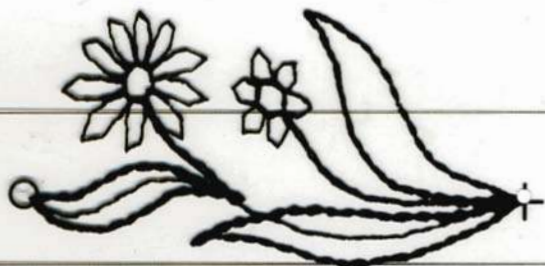
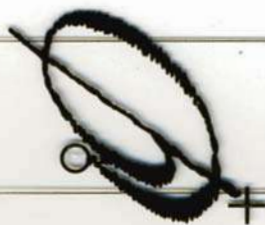
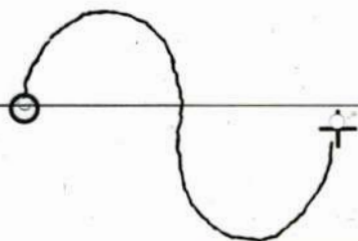
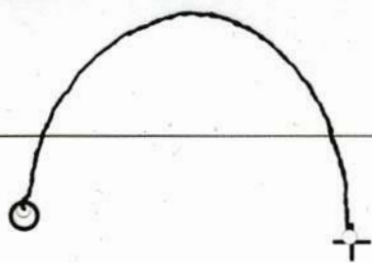

○ - START + - END

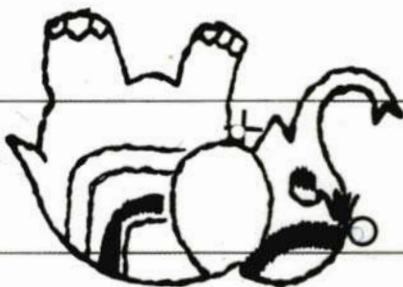
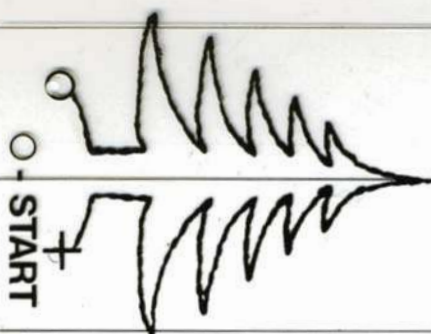
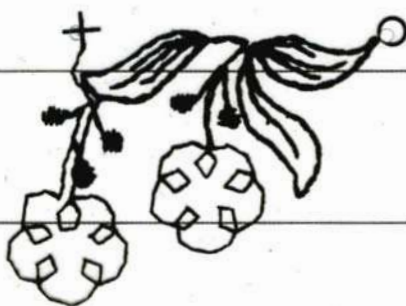
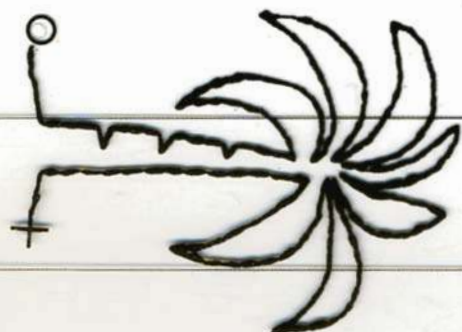
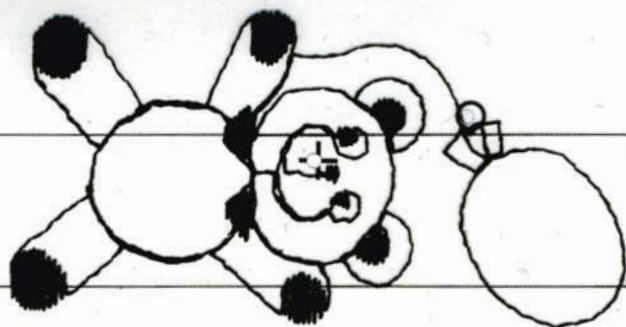
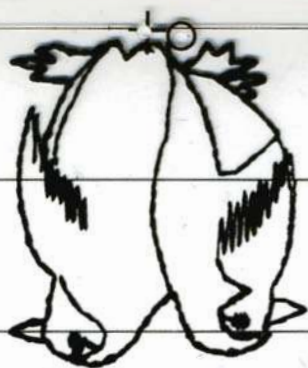

○ - START + - END



BERNINA 1630

BERNINA®

© Copyright 1993 by Fritz Gegauf AG, Steckborn